



US 20180108718A1

(19) **United States**

(12) **Patent Application Publication**
WANG

(10) **Pub. No.: US 2018/0108718 A1**
(43) **Pub. Date: Apr. 19, 2018**

(54) **ORGANIC LIGHT-EMITTING DIODE PANEL AND MANUFACTURING METHOD USING THE SAME**

(52) **U.S. Cl.**
CPC *H01L 27/3244* (2013.01); *H01L 51/5206* (2013.01); *H01L 51/0508* (2013.01); *H01L 51/5056* (2013.01); *H01L 51/5221* (2013.01)

(71) Applicant: **FocalTech Systems Co., Ltd.**, Hsinchu City (TW)

(57) **ABSTRACT**

(72) Inventor: **Chun-Fu WANG**, Hsinchu City (TW)

An organic light-emitting diode panel and a manufacturing method using the same are provided in the present invention. The OLED panel includes at least a pixel. The pixel includes a anode conducting layer, an insulation layer, an emitting layer (EML), a cathode layer and a reference voltage layer. The anode conducting layer is disposed on a transparent substrate. The insulation layer is disposed on the anode conducting layer and has a first cavity and a second cavity, wherein there is a distance between the first anode layer and the bottom of second cavity. There are a hole injection layer (HIL) and a hole transmission layer (HTL). The HIL is disposed on the first anode conducting layer. The HTL is disposed on the HIL. There are a cathode layer, an electronic injection layer (EIL) and an electronic transmission layer (ETL) in the second cavity. The cathode layer is exposed by the bottom of the second cavity. The EIL is disposed on the cathode layer. The ETL is disposed on the EIL. The EML is disposed on the insulation layer. The reference voltage layer is disposed on the EML.

(21) Appl. No.: **15/787,310**

(22) Filed: **Oct. 18, 2017**

(30) **Foreign Application Priority Data**

Oct. 19, 2016 (TW) 105133678
Jun. 30, 2017 (TW) 106121905

Publication Classification

(51) **Int. Cl.**
H01L 27/32 (2006.01)
H01L 51/52 (2006.01)
H01L 51/50 (2006.01)
H01L 51/05 (2006.01)

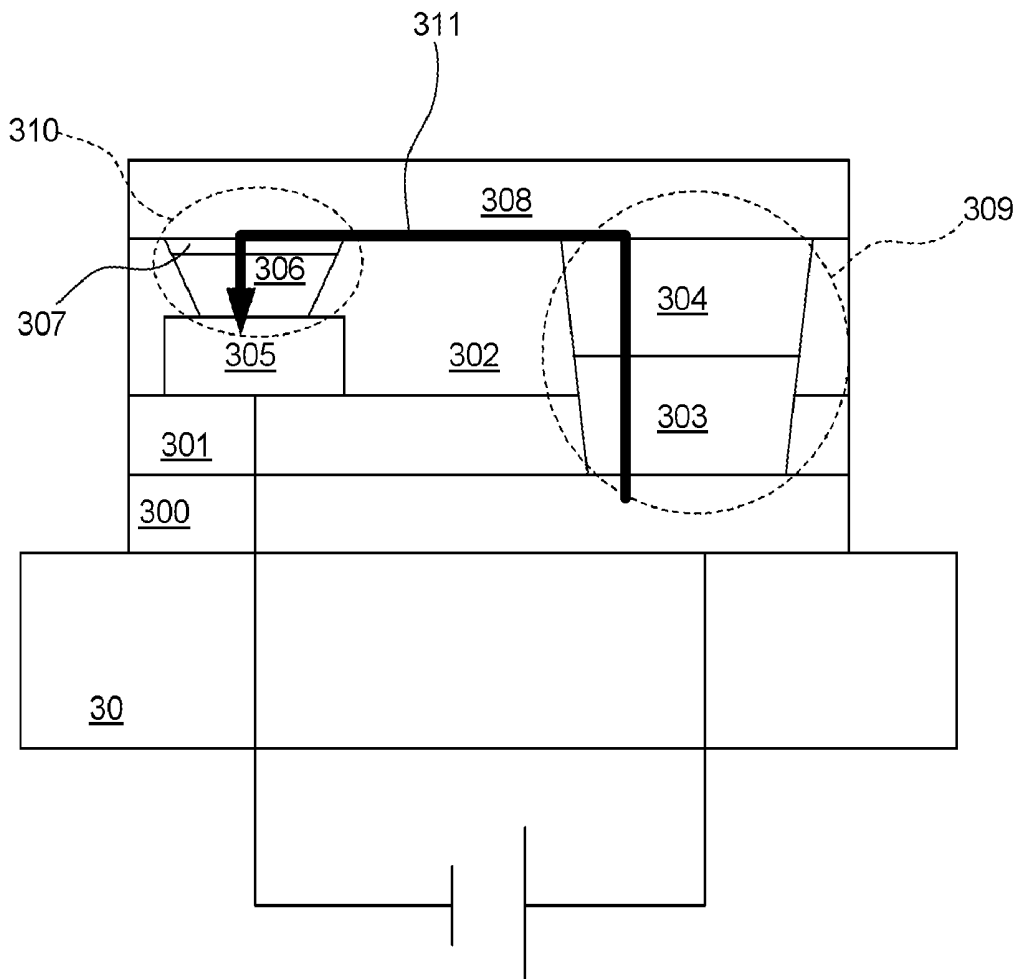

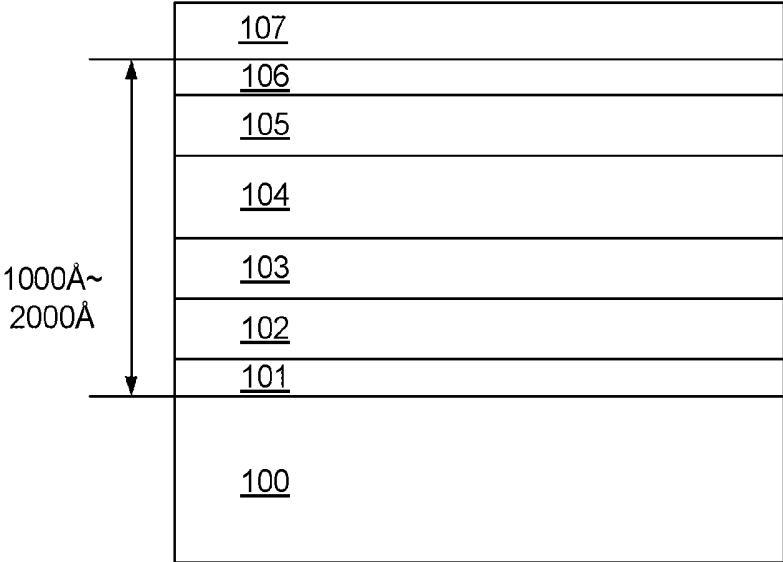

FIG. 1
(Prior Art)

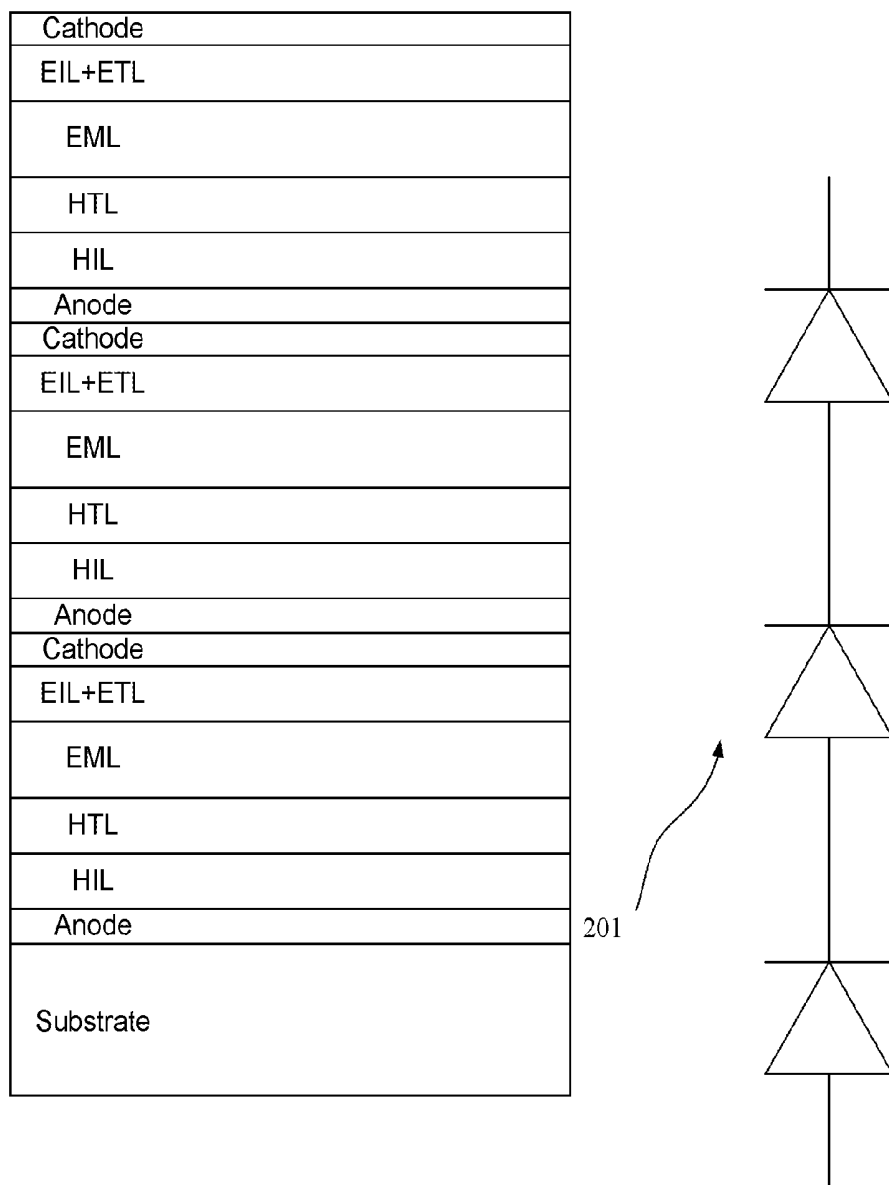

FIG. 2
(Prior Art)

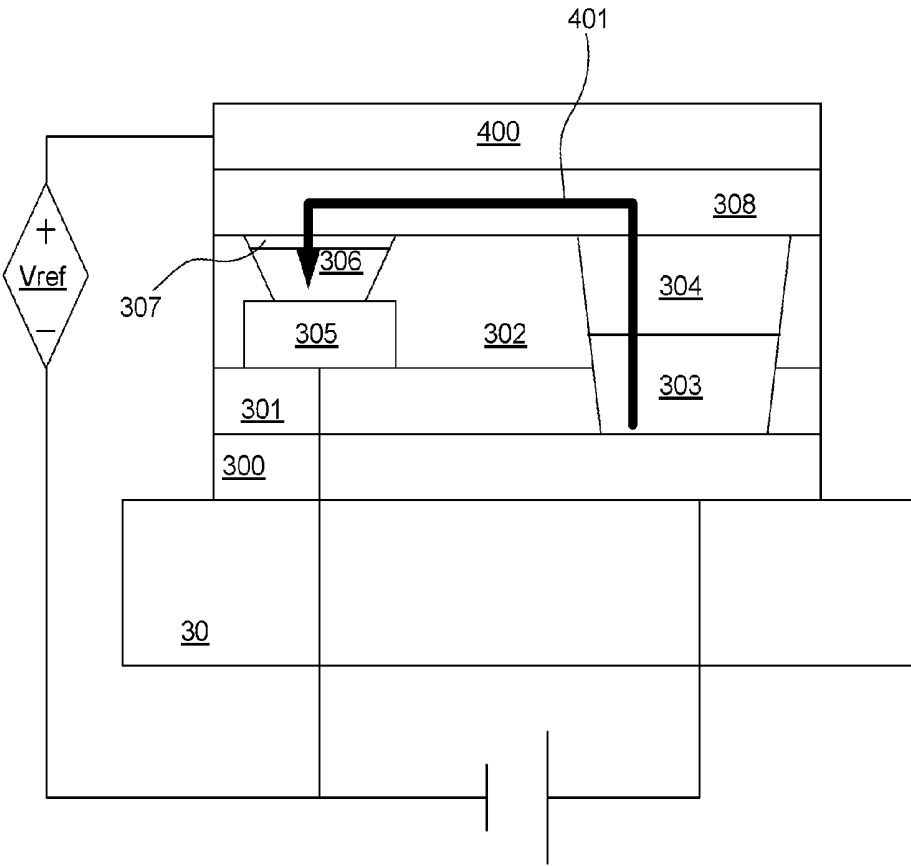

FIG. 4

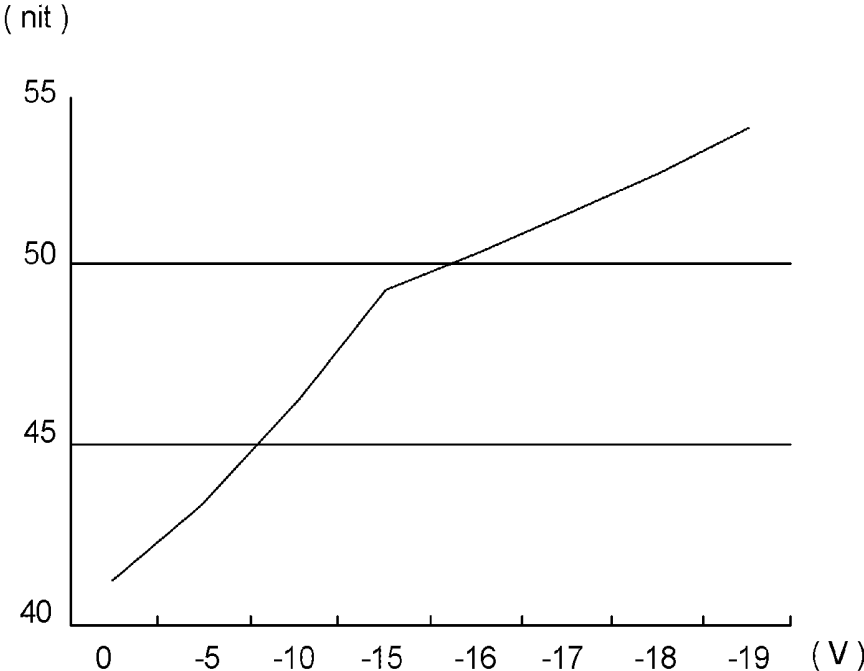

FIG. 5

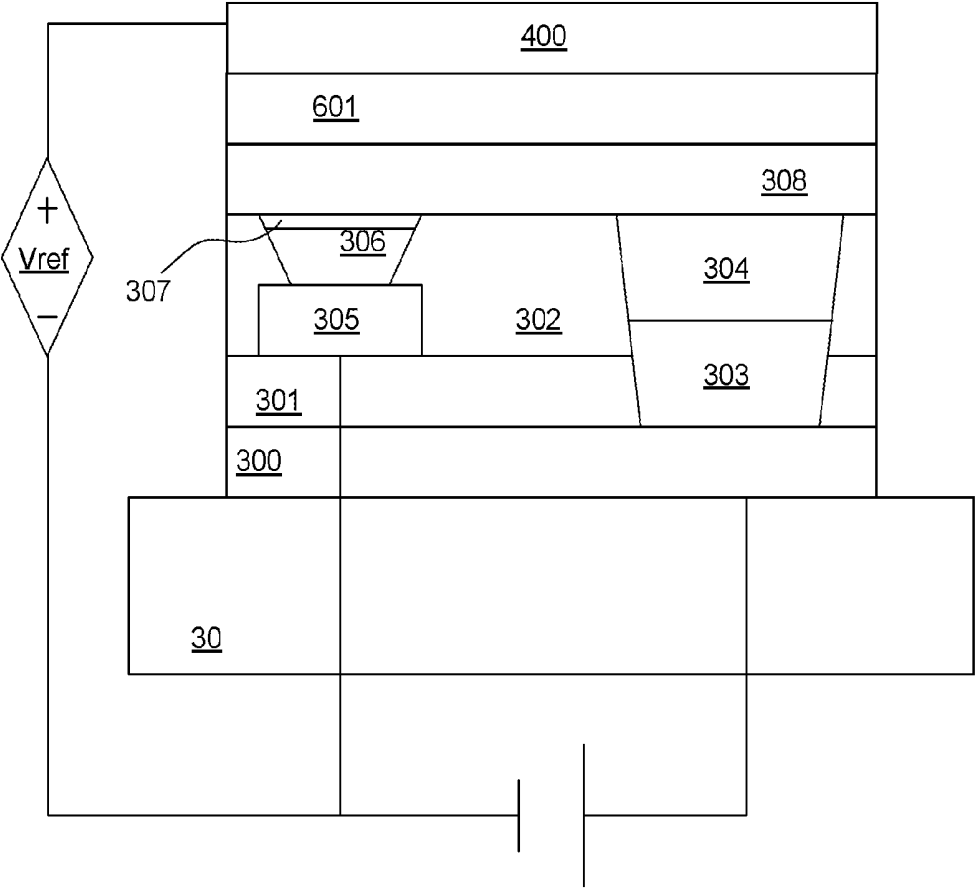

FIG. 6

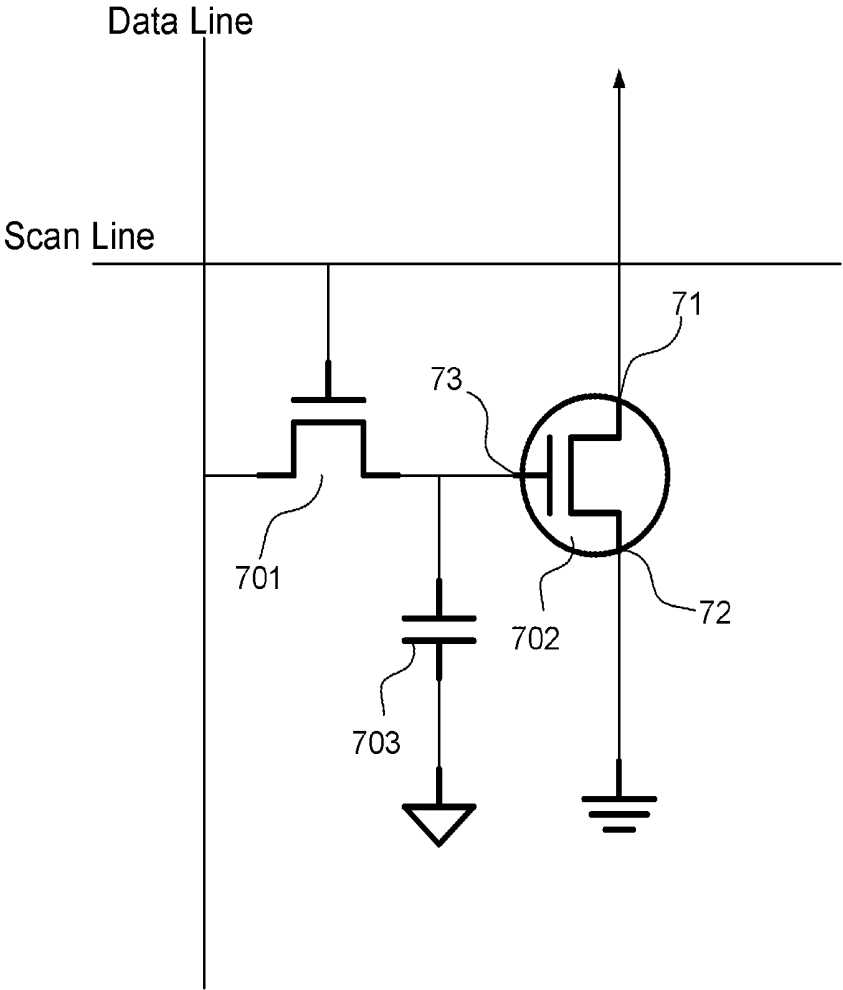

FIG. 7

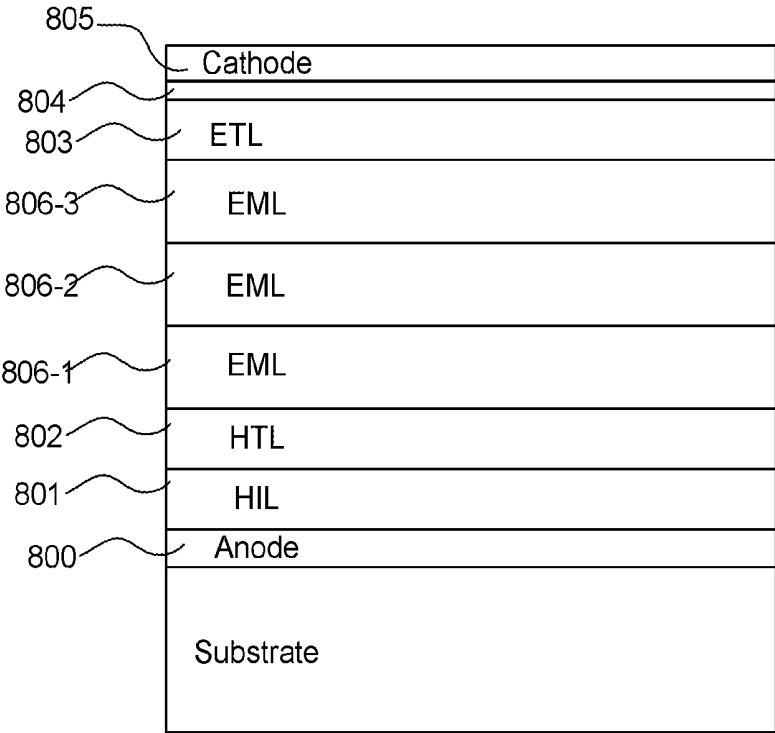

FIG. 8A

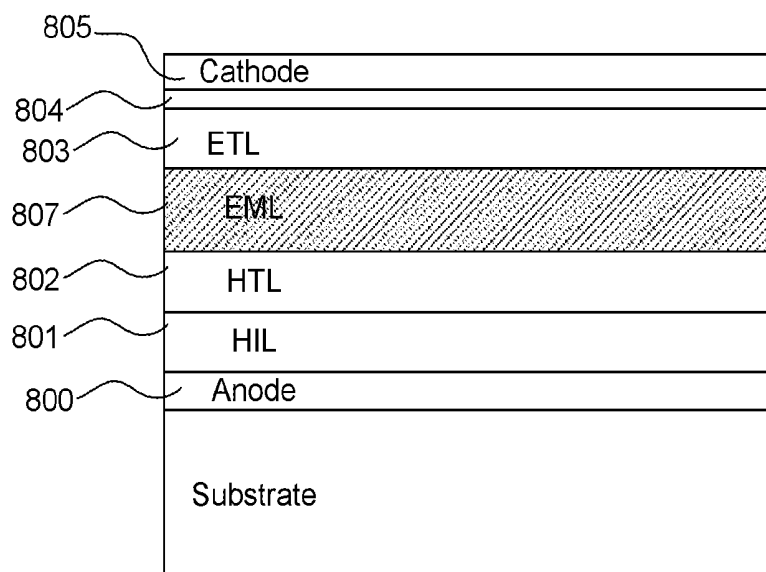

FIG. 8B

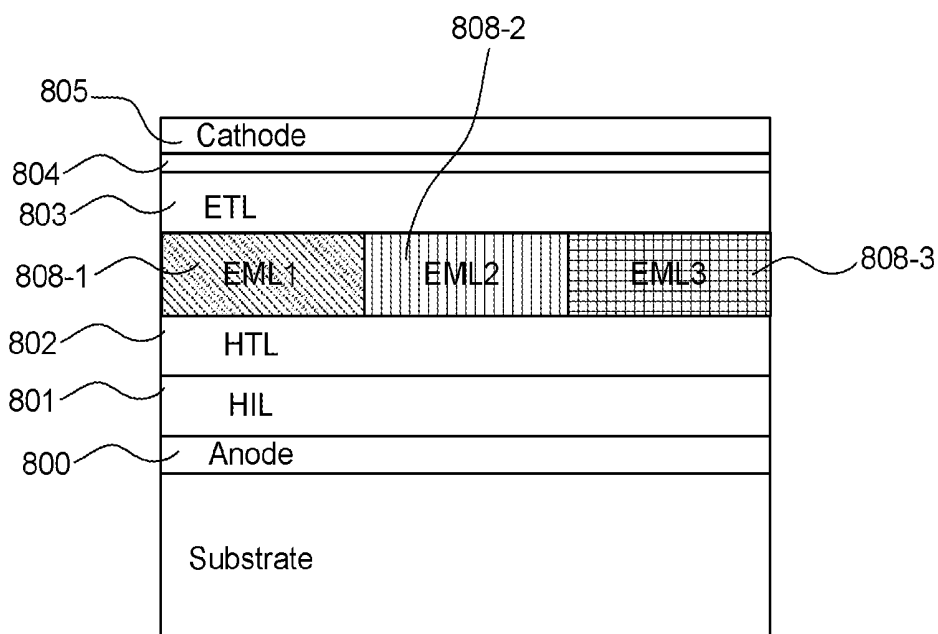

FIG. 8C

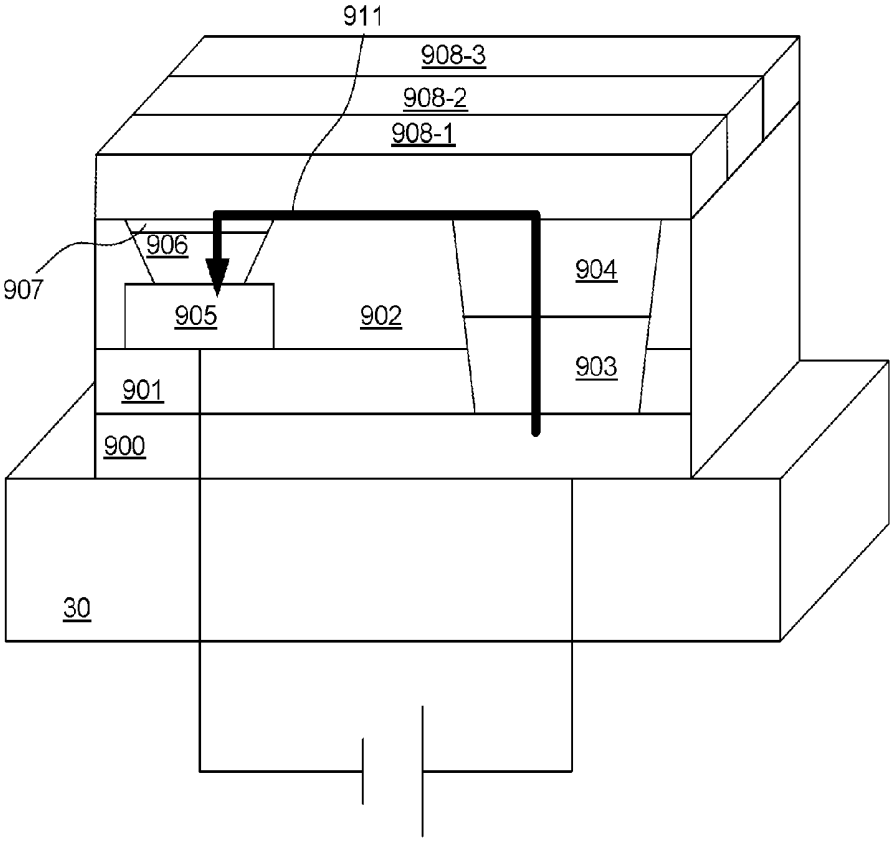

FIG. 9A

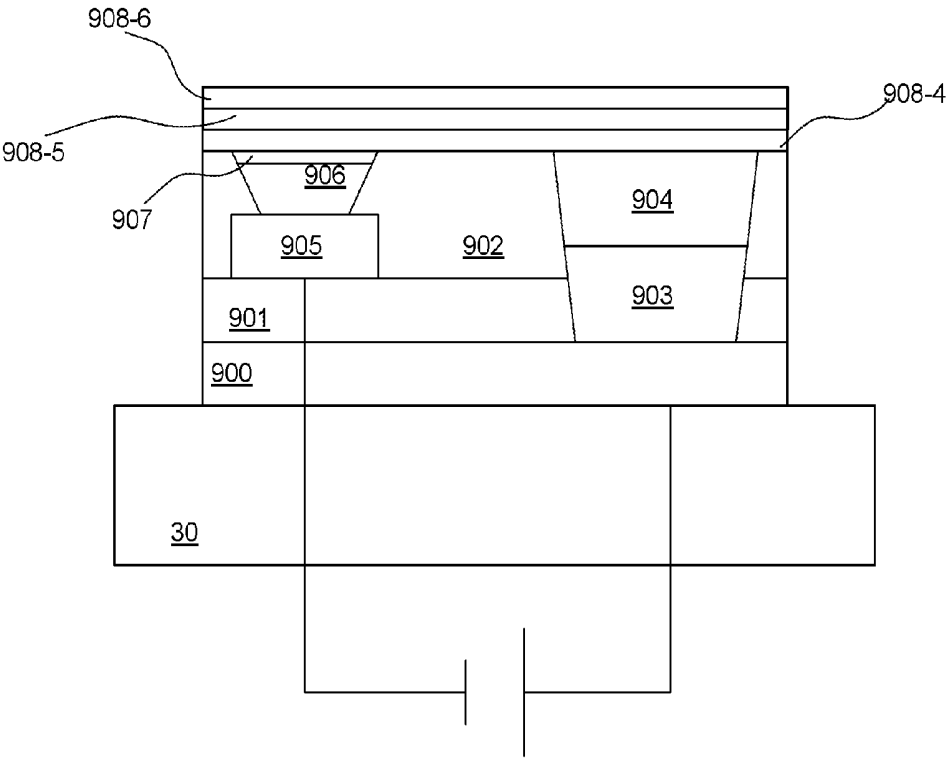

FIG. 9B

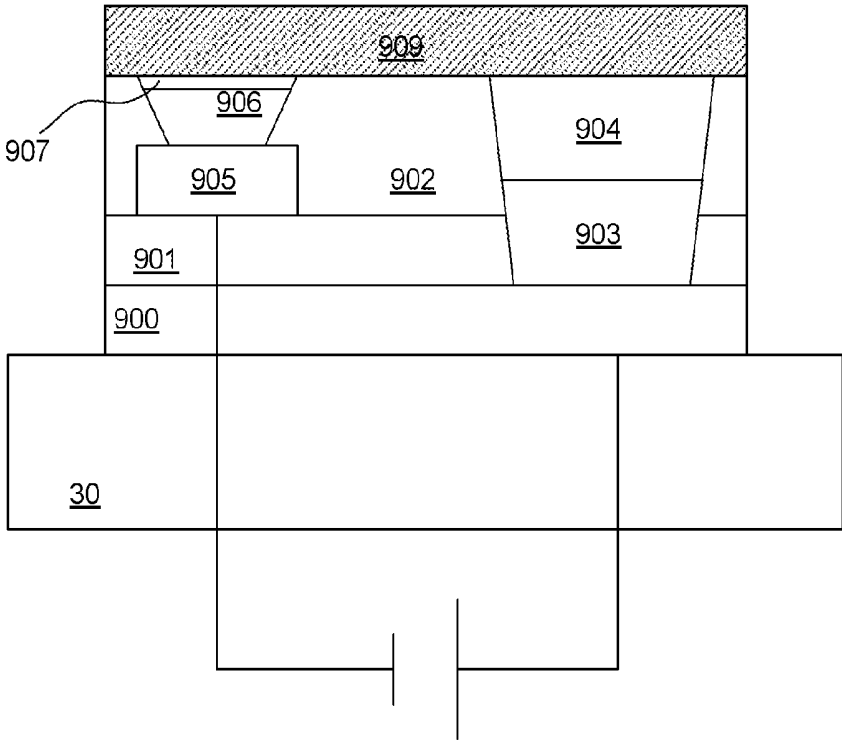

FIG. 9C

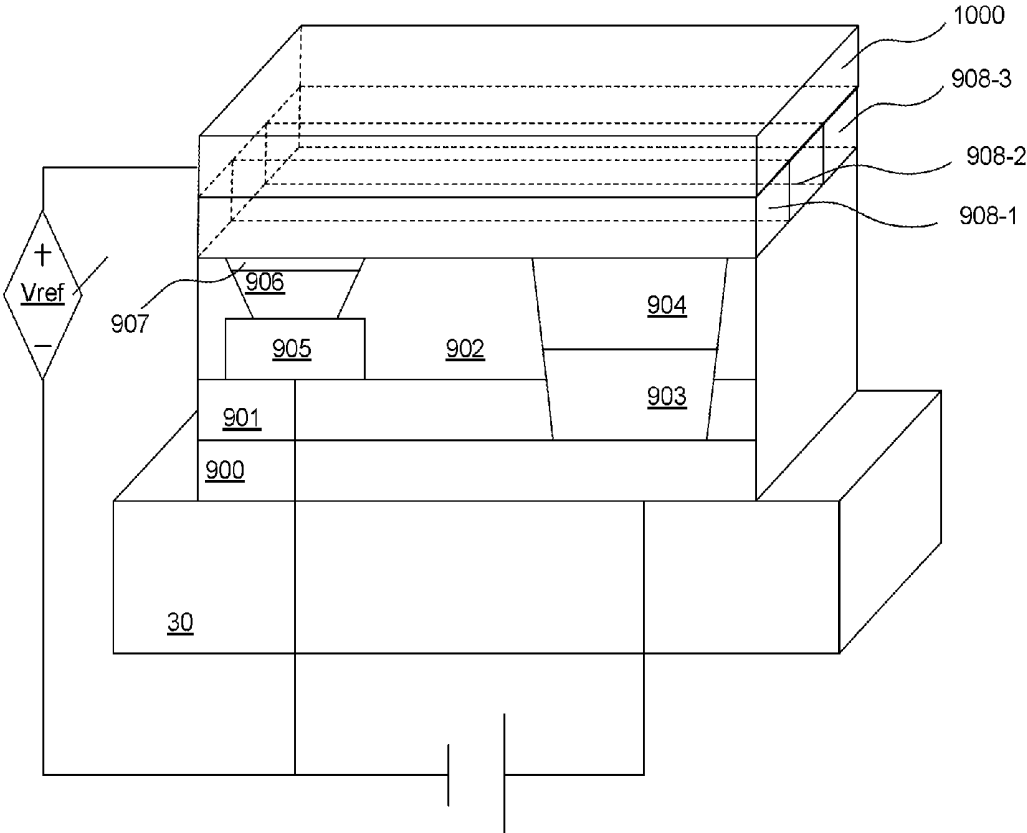

FIG. 10A

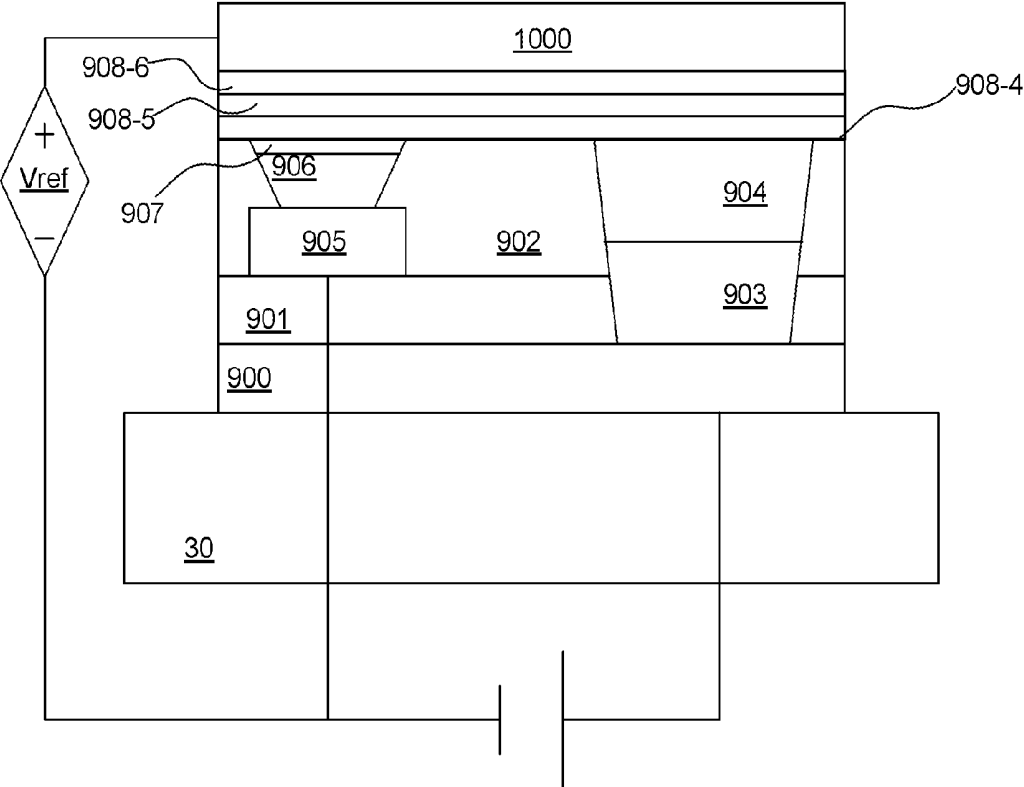

FIG. 10B

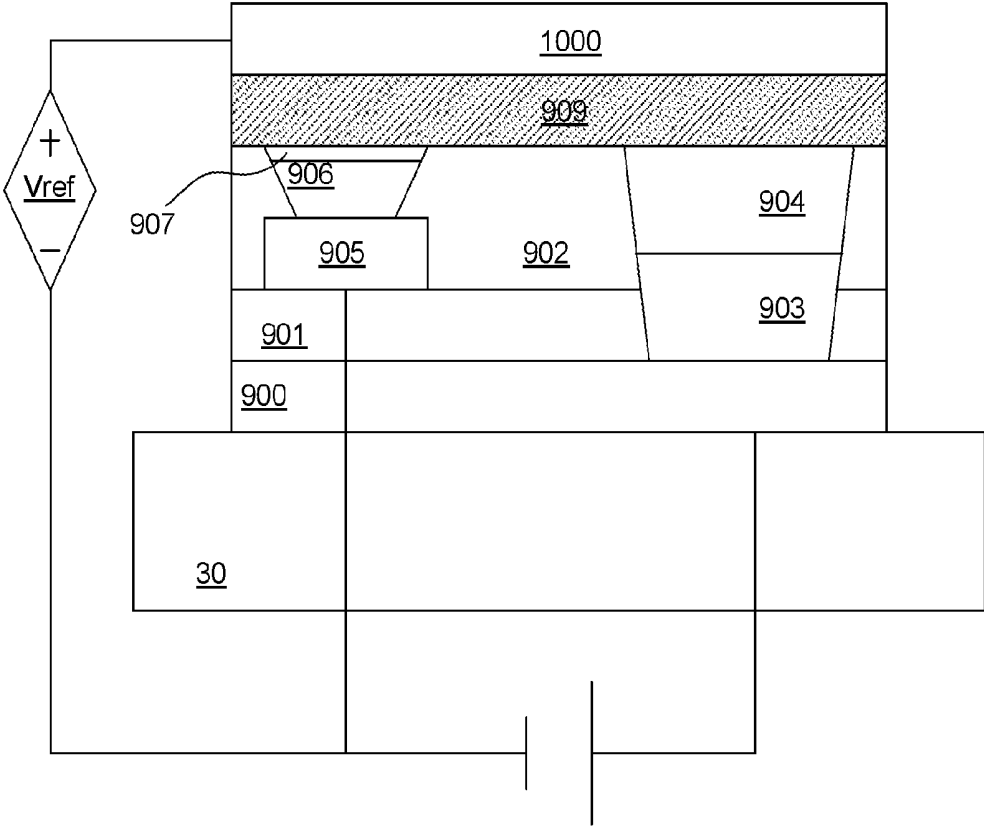

FIG. 10C

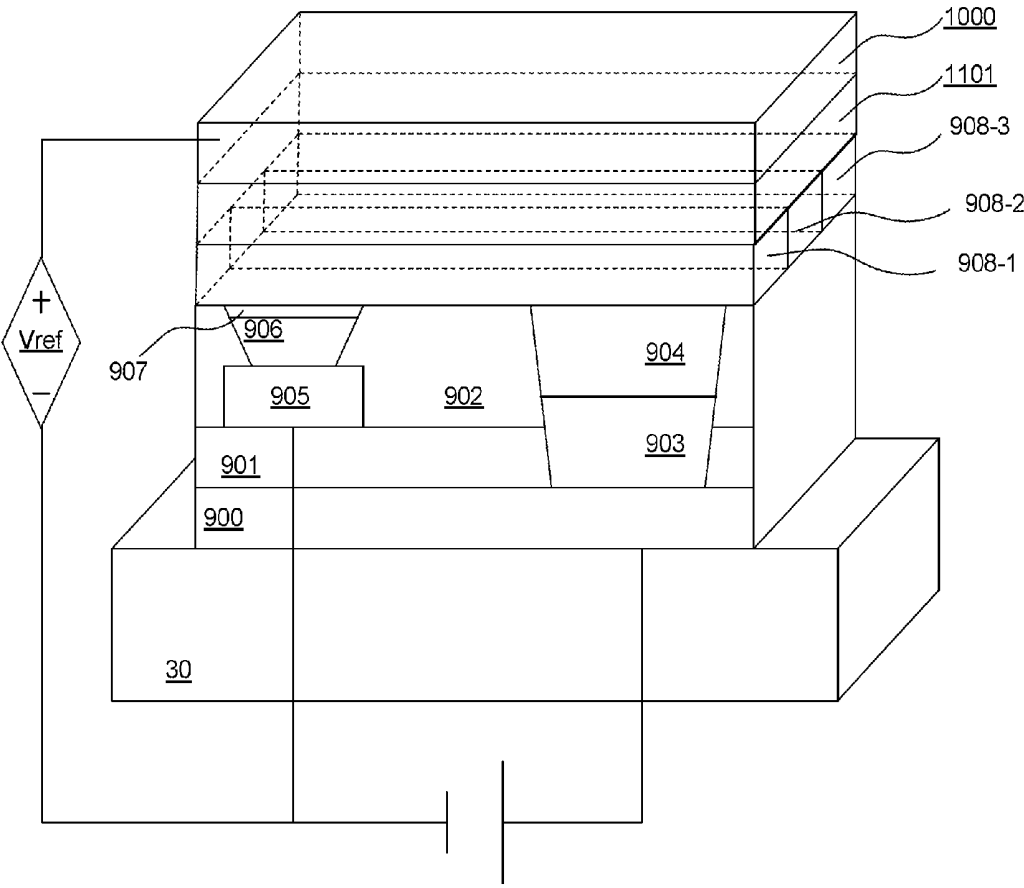

FIG. 11

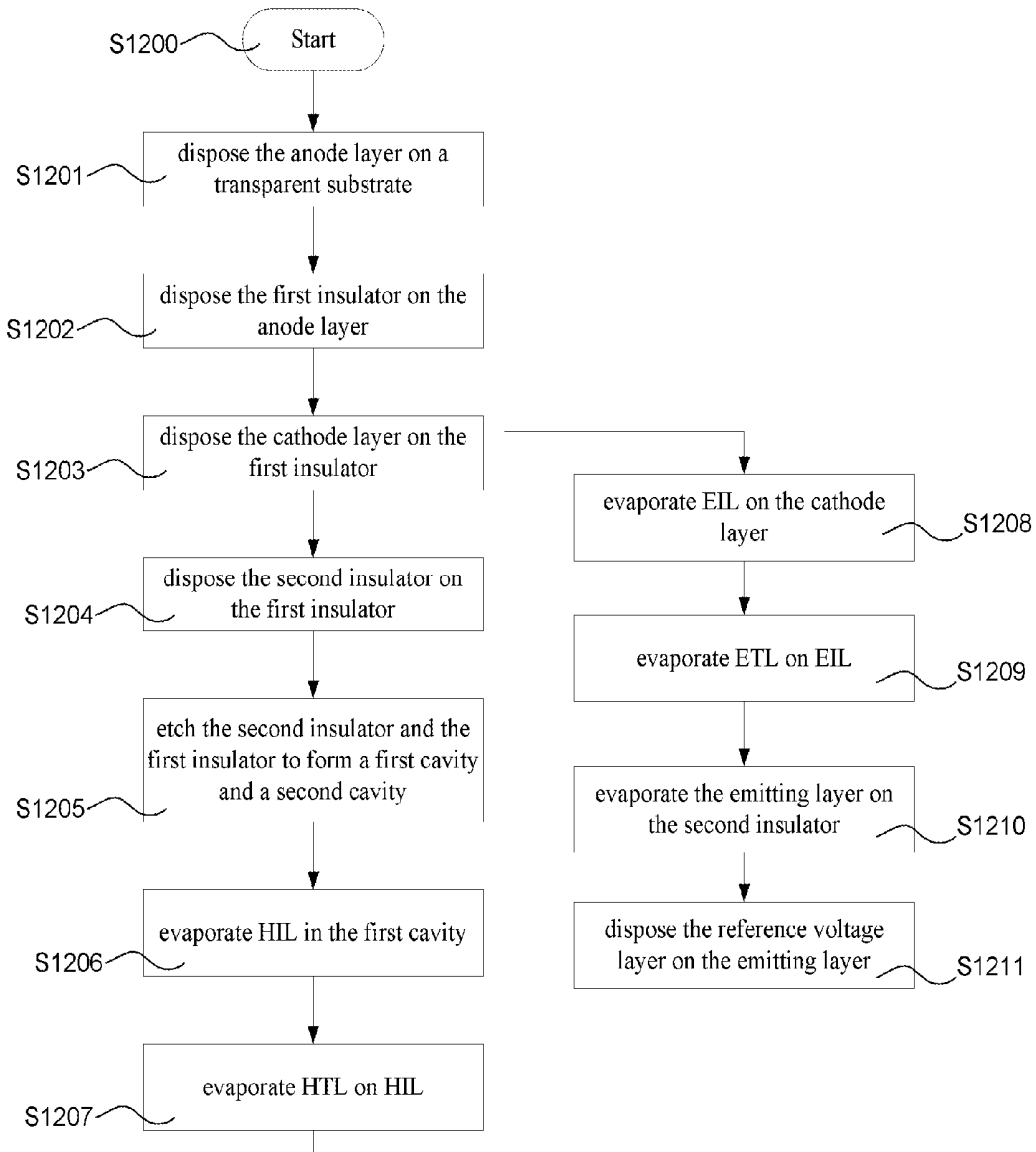

FIG. 12

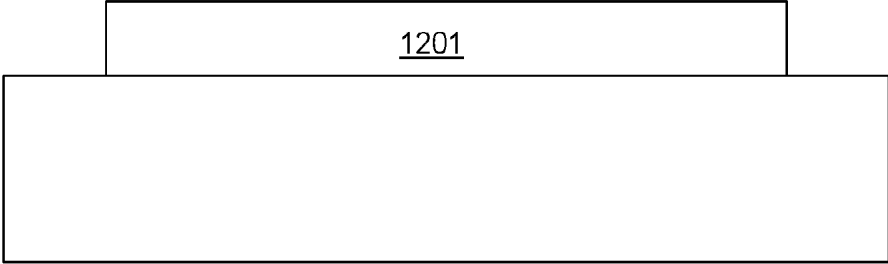

FIG. 12A

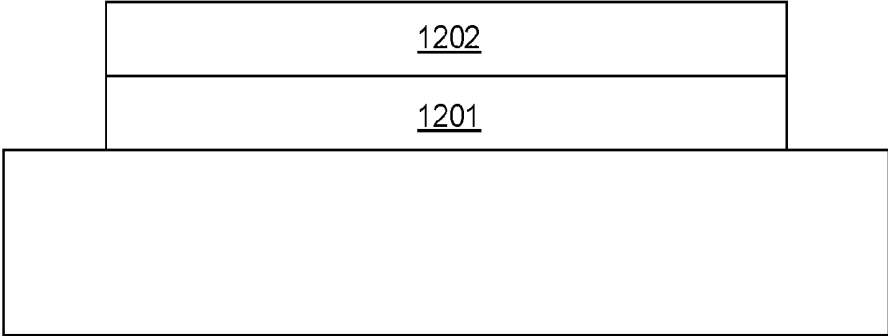

FIG. 12B

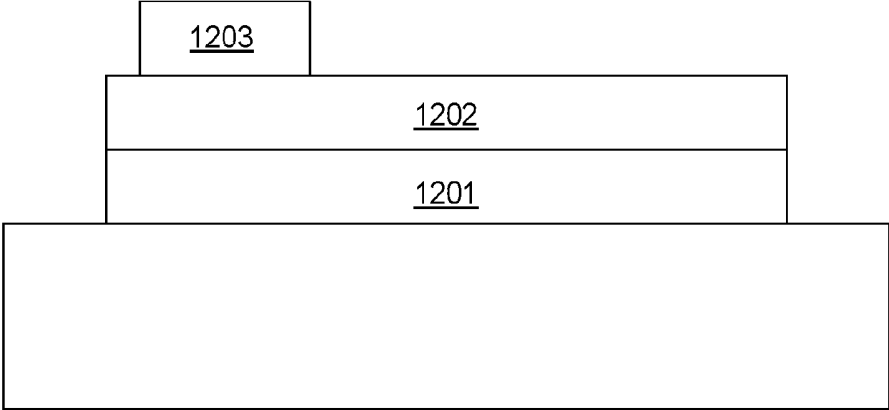

FIG. 12C

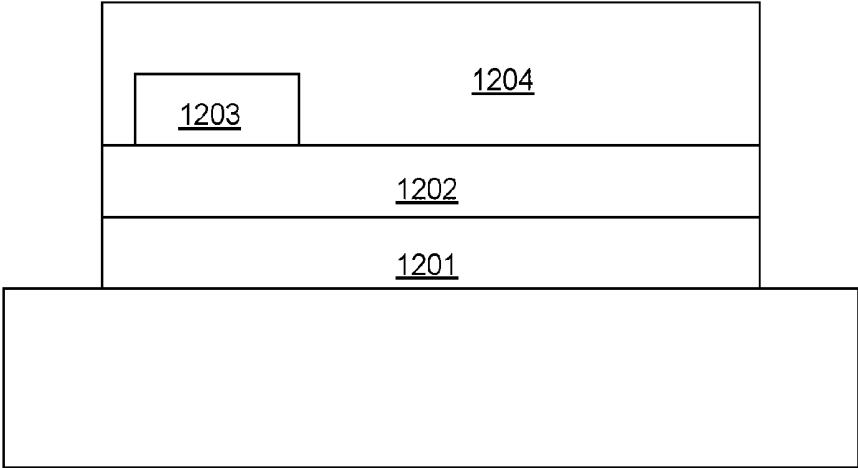

FIG. 12D

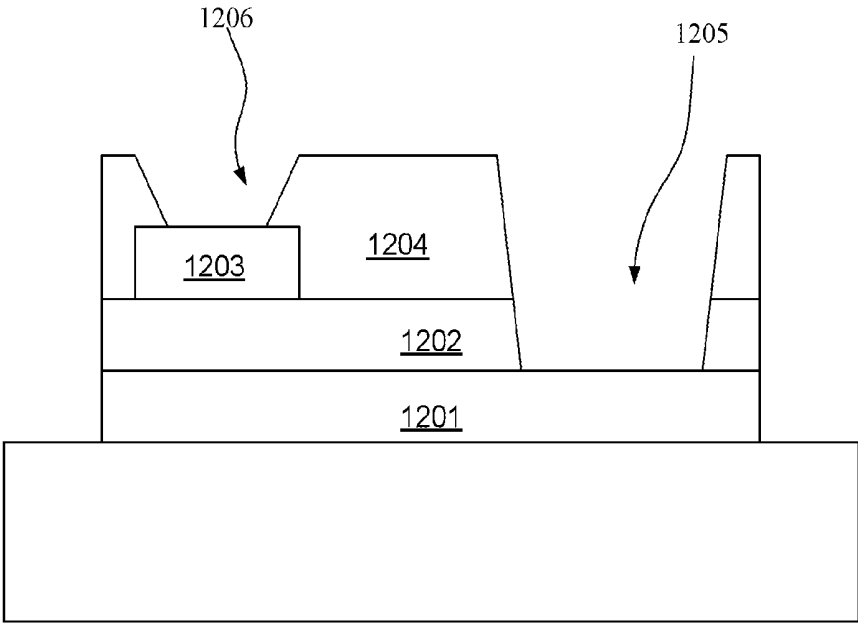

FIG. 12E

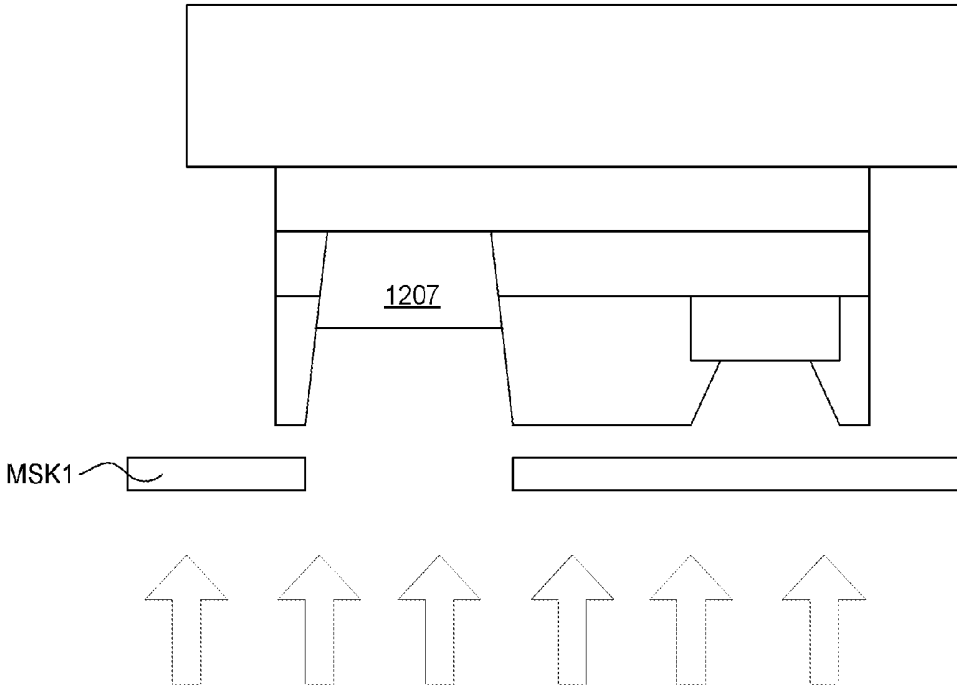

FIG. 12F

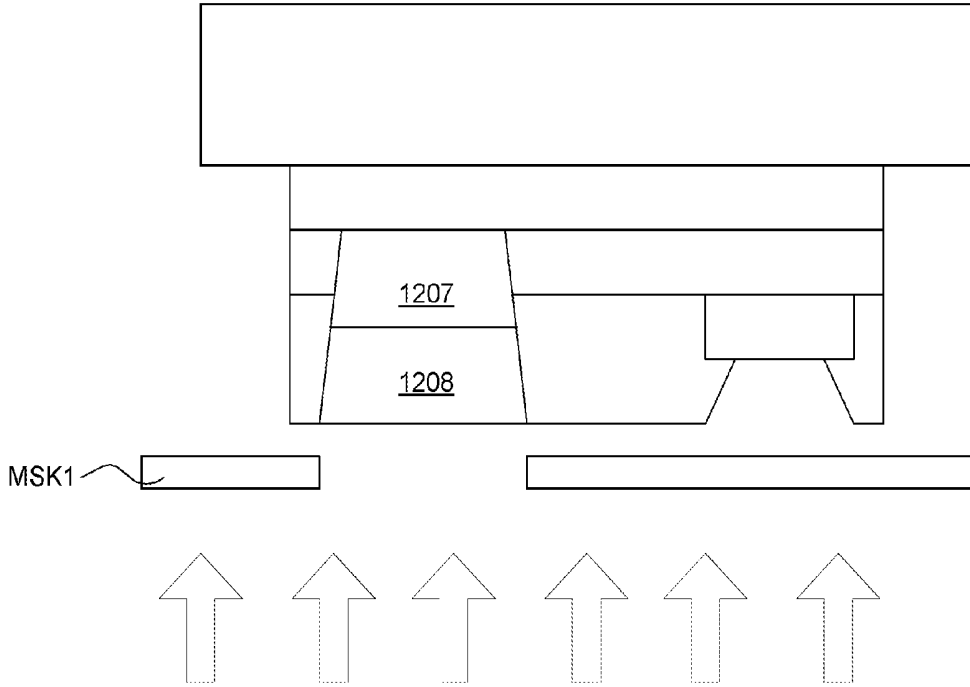

FIG. 12G

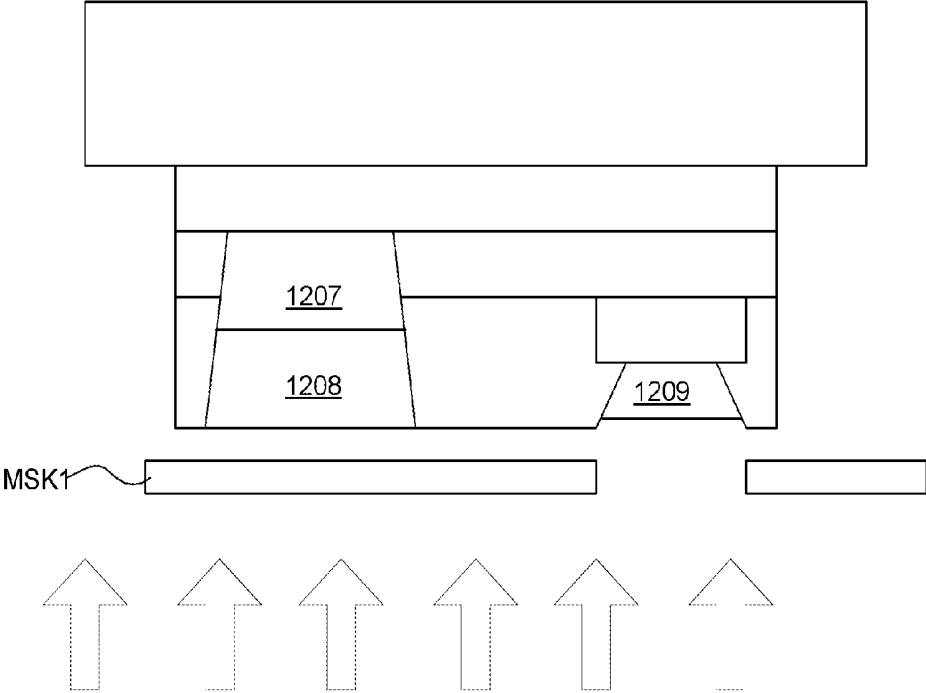

FIG. 12H

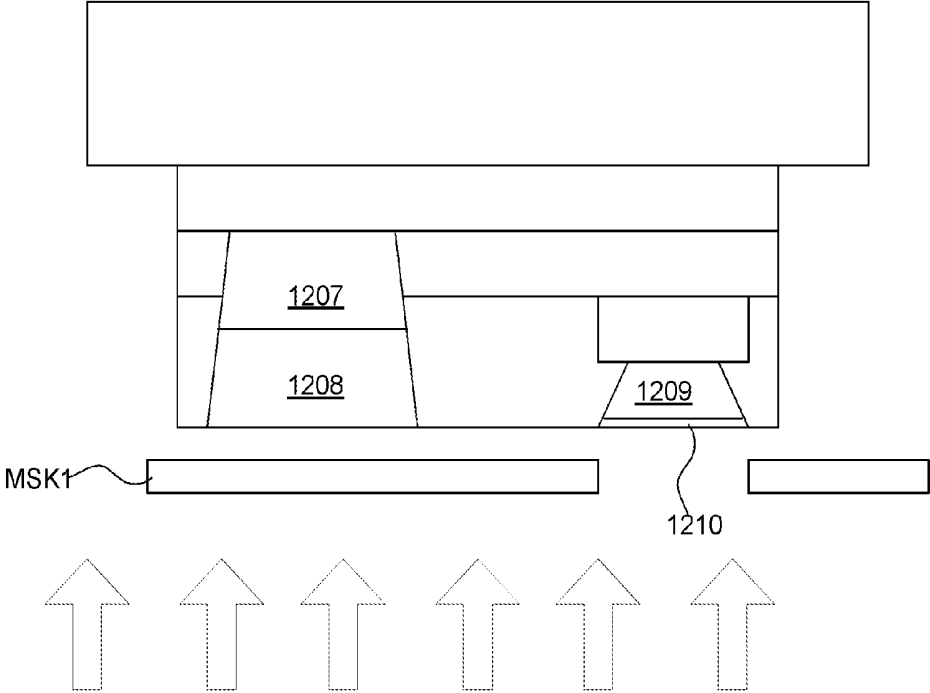

FIG. 12I

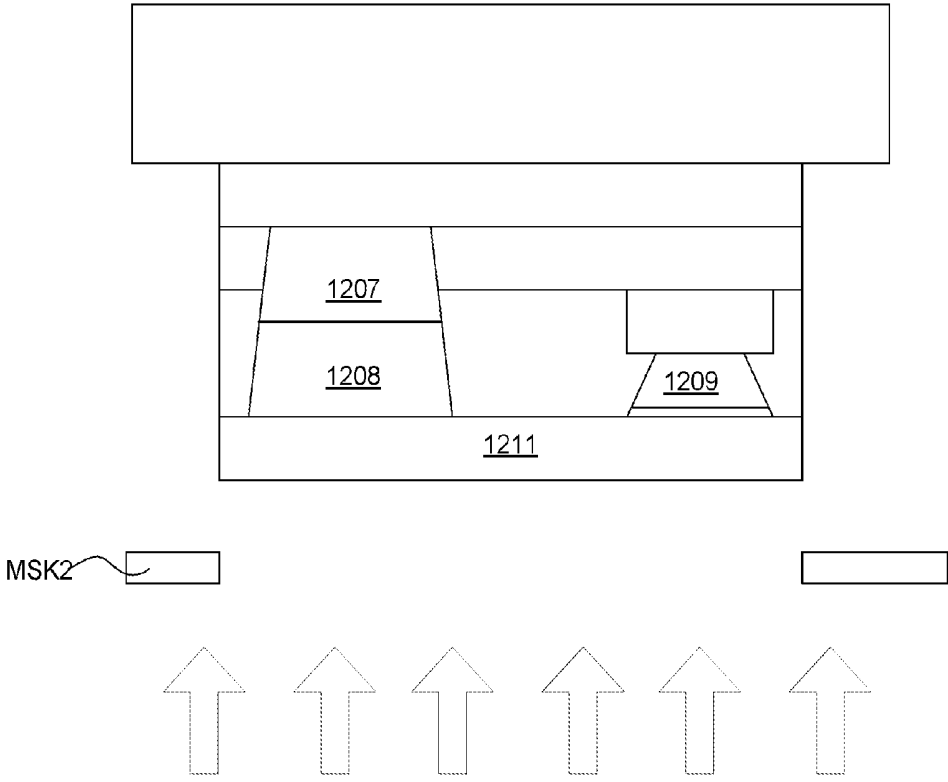

FIG. 12J

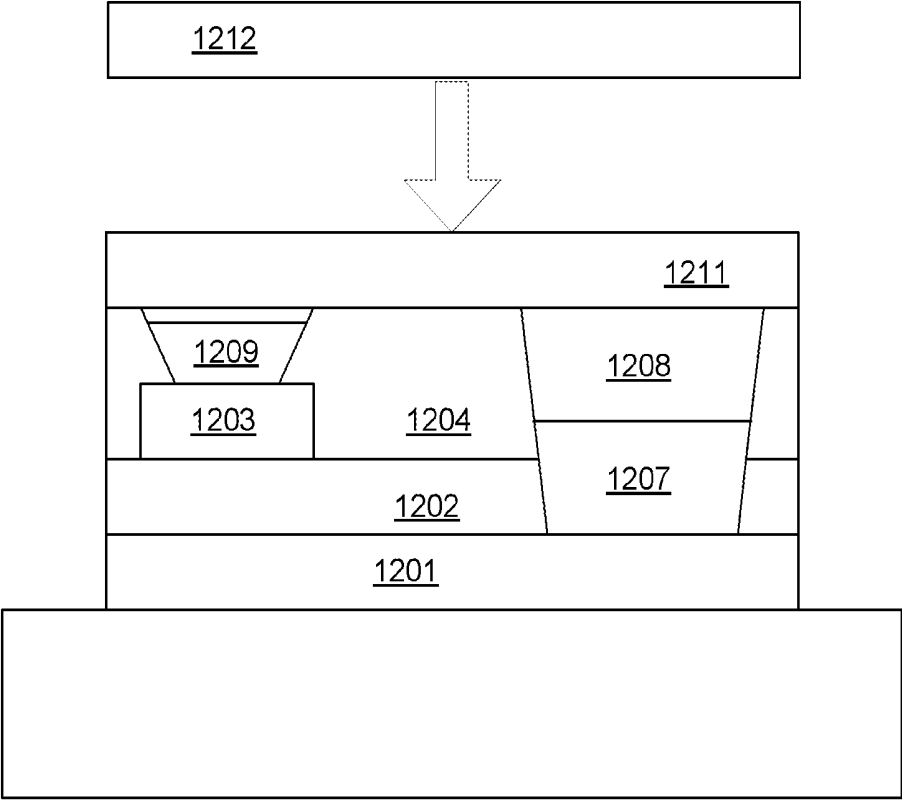

FIG. 12K

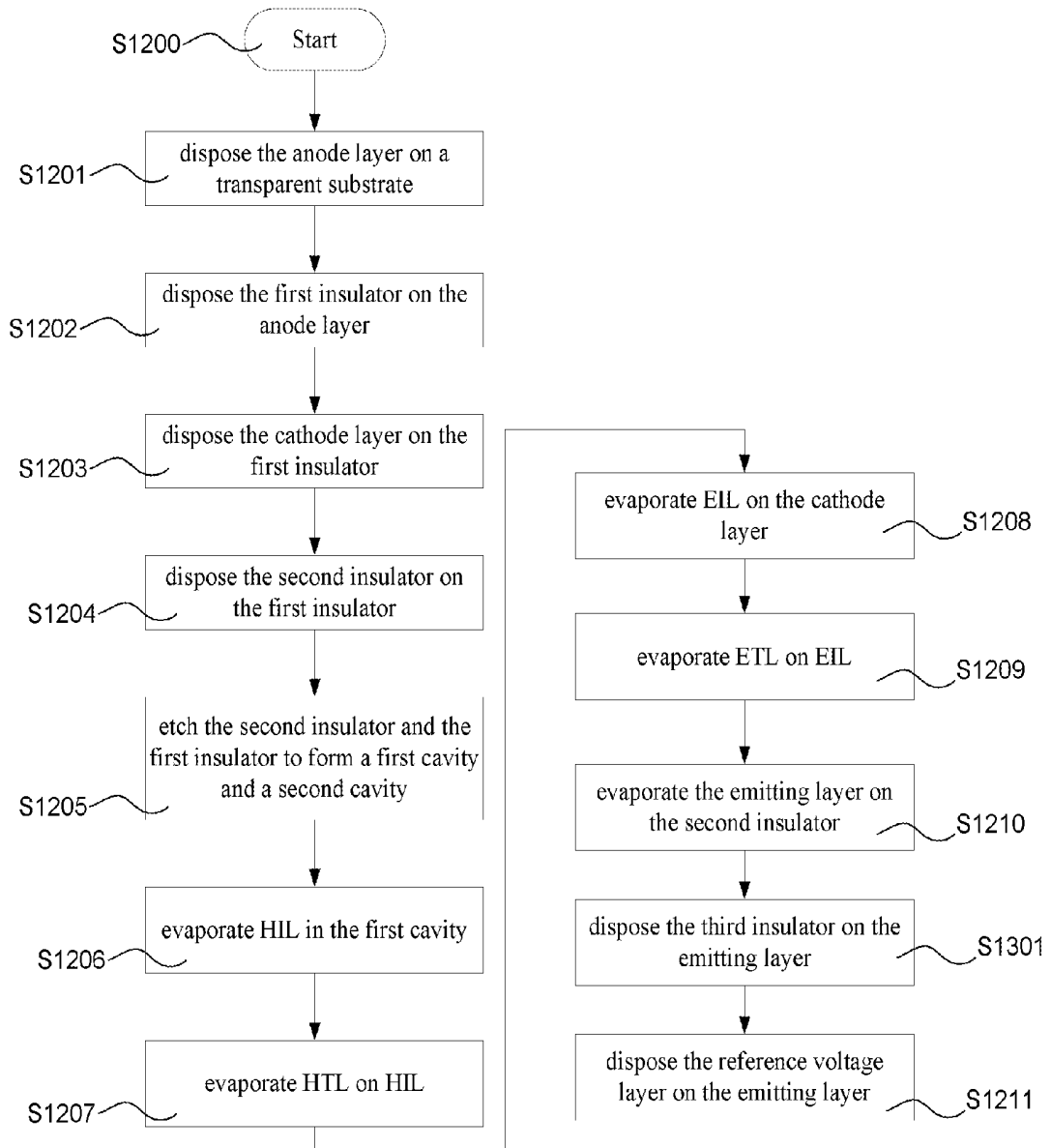

FIG. 13

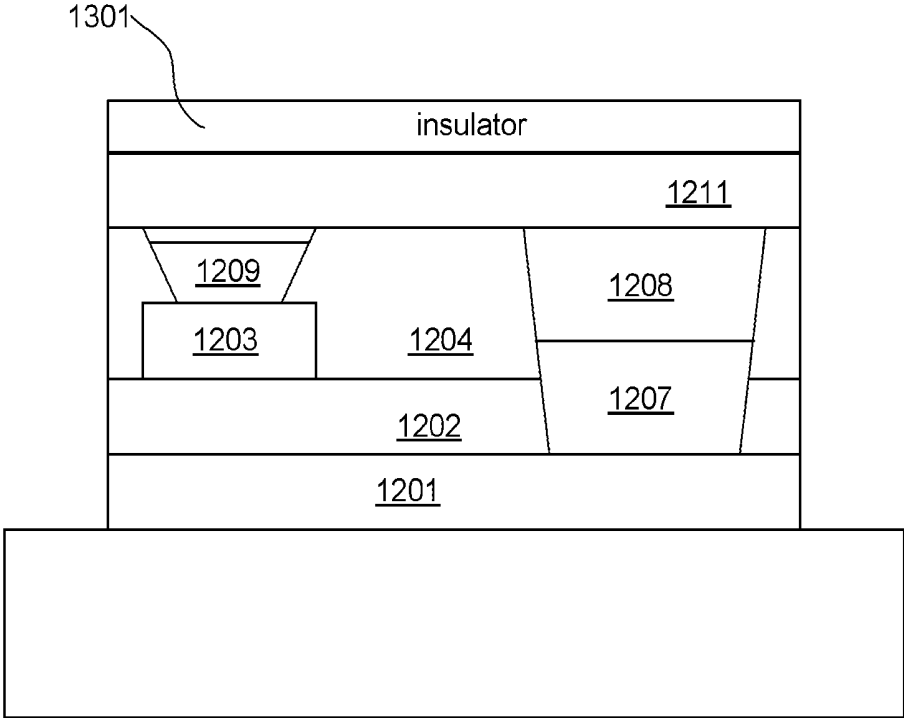

FIG. 13A

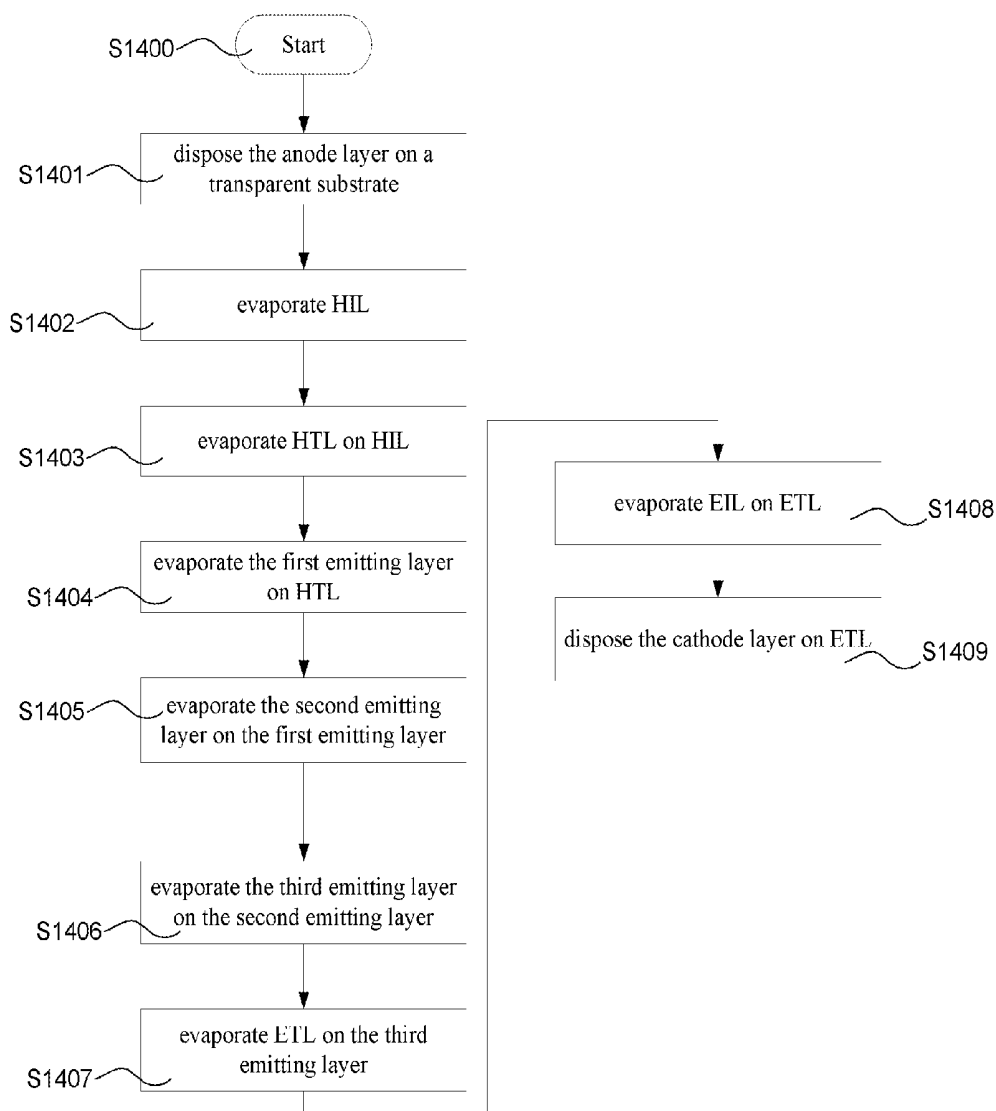

FIG. 14

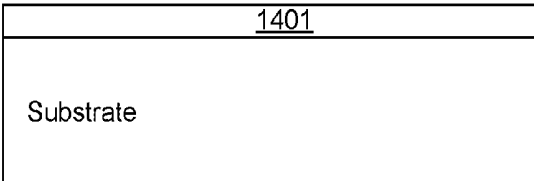

FIG. 14A

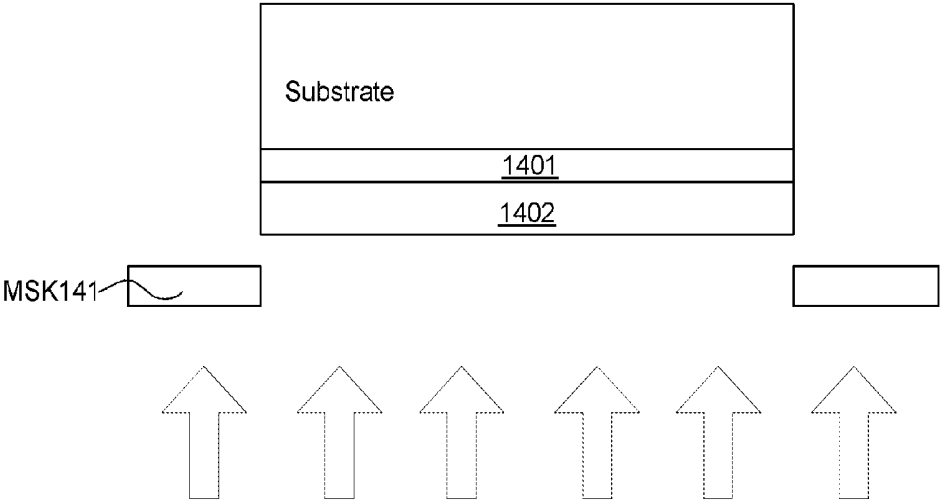

FIG. 14B

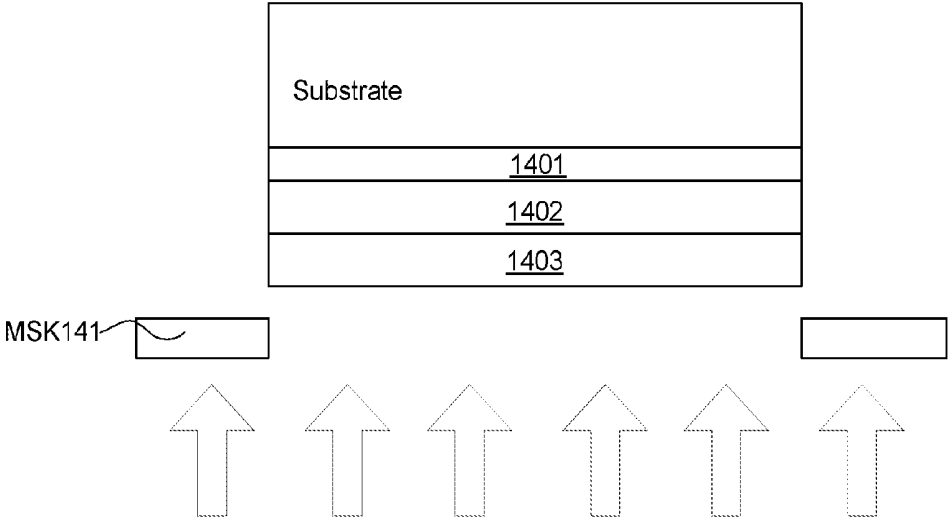

FIG. 14C

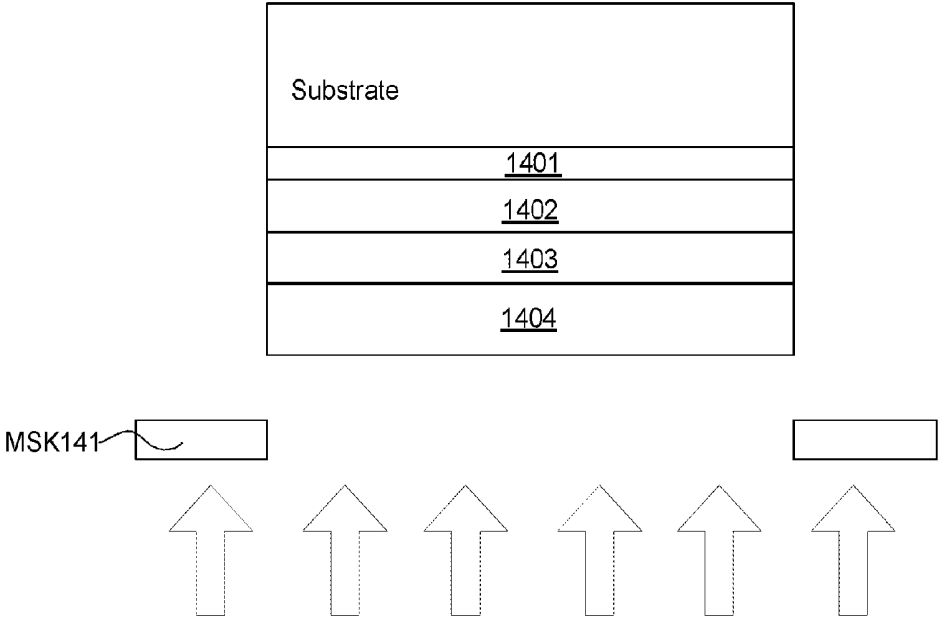

FIG. 14D

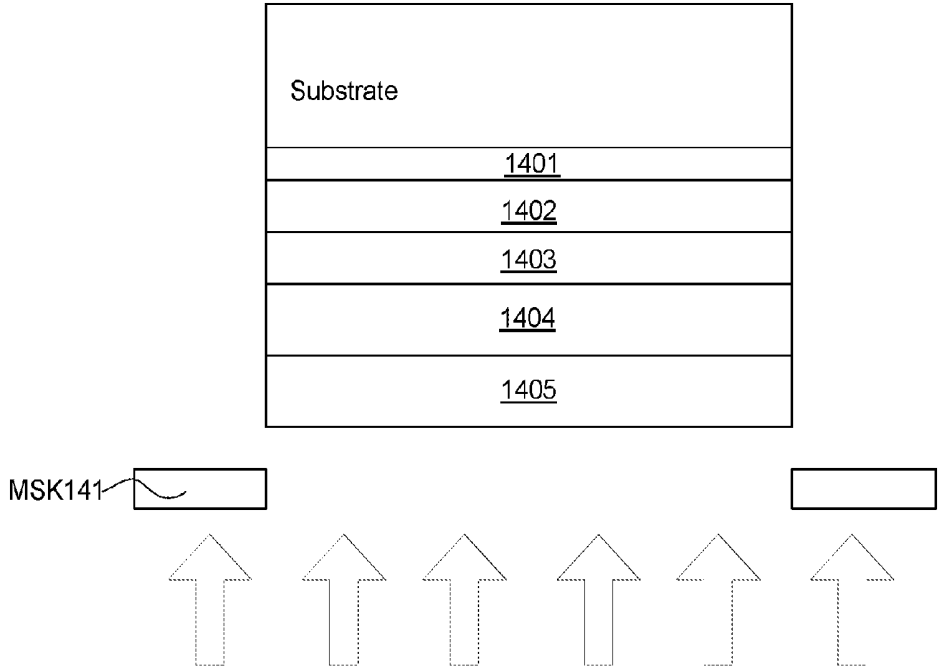

FIG. 14E

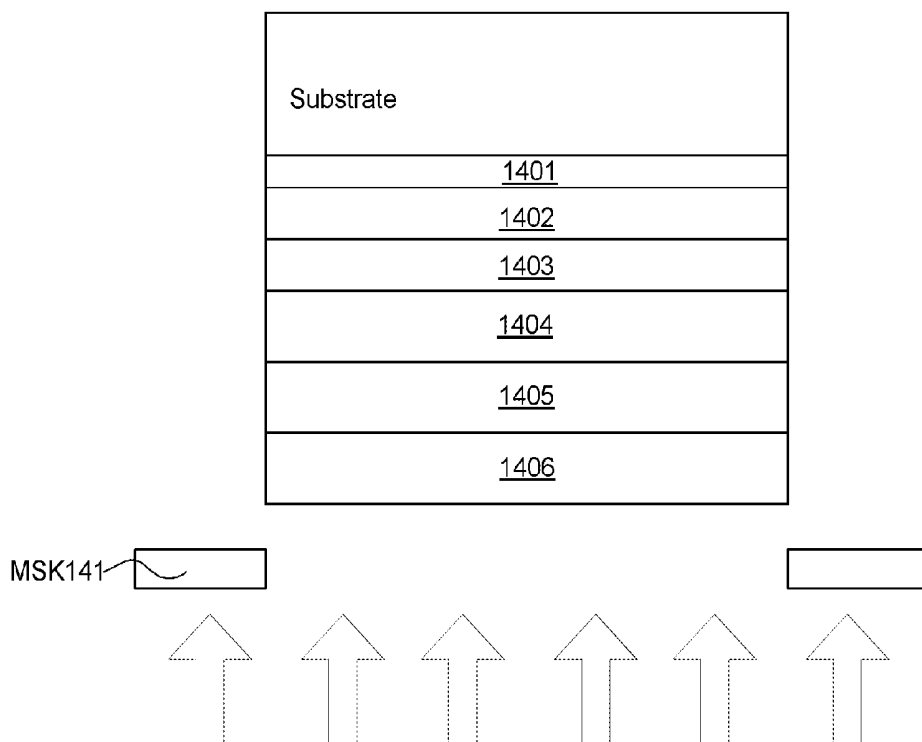

FIG. 14F

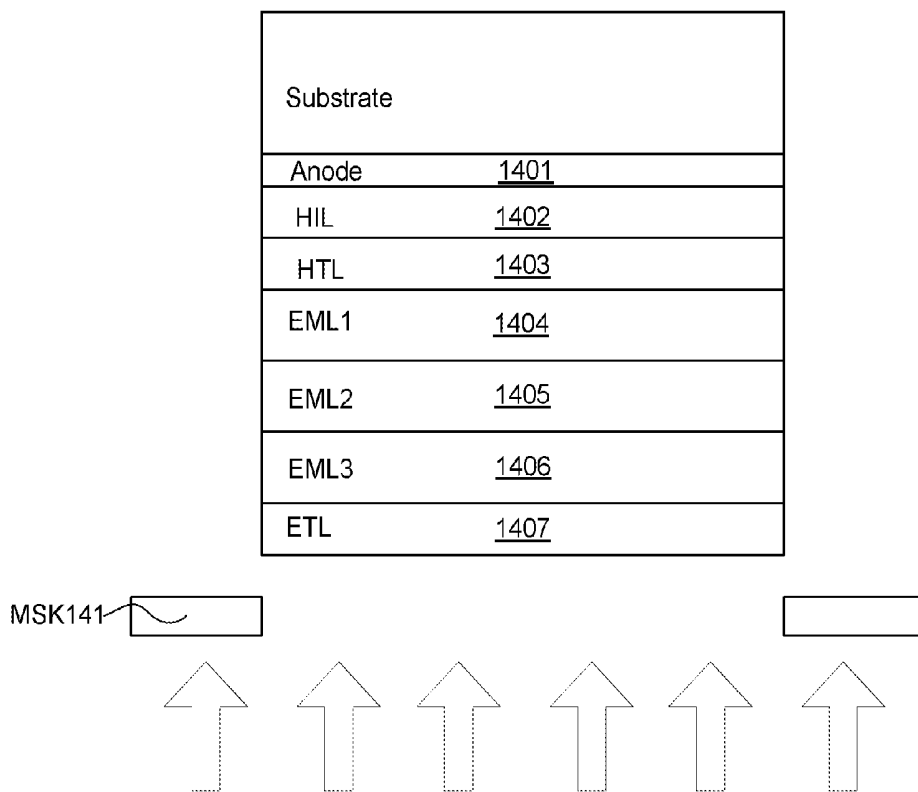

FIG. 14G

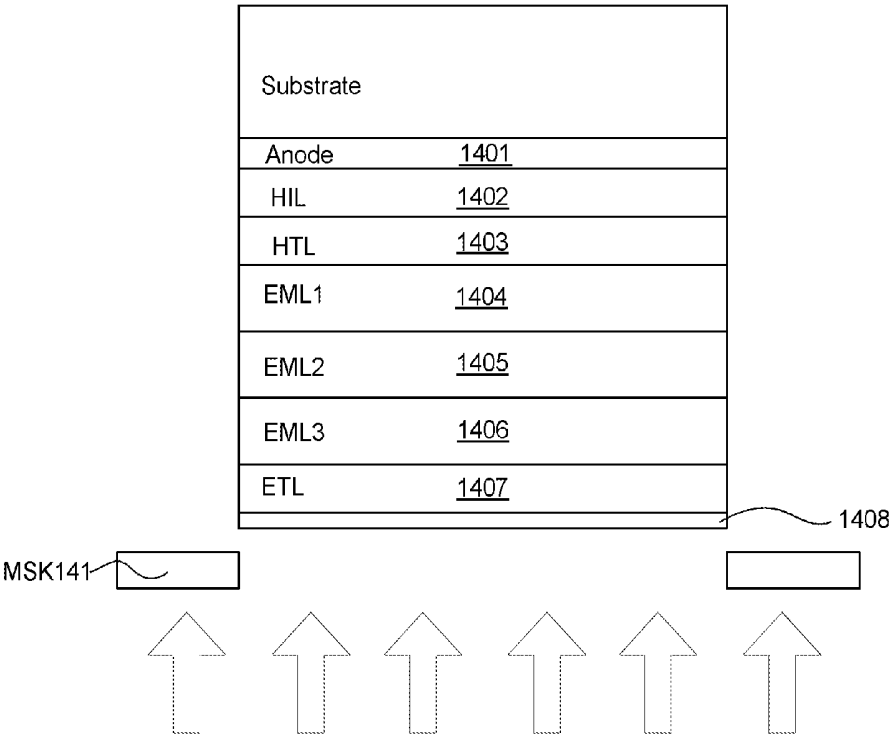

FIG. 14H

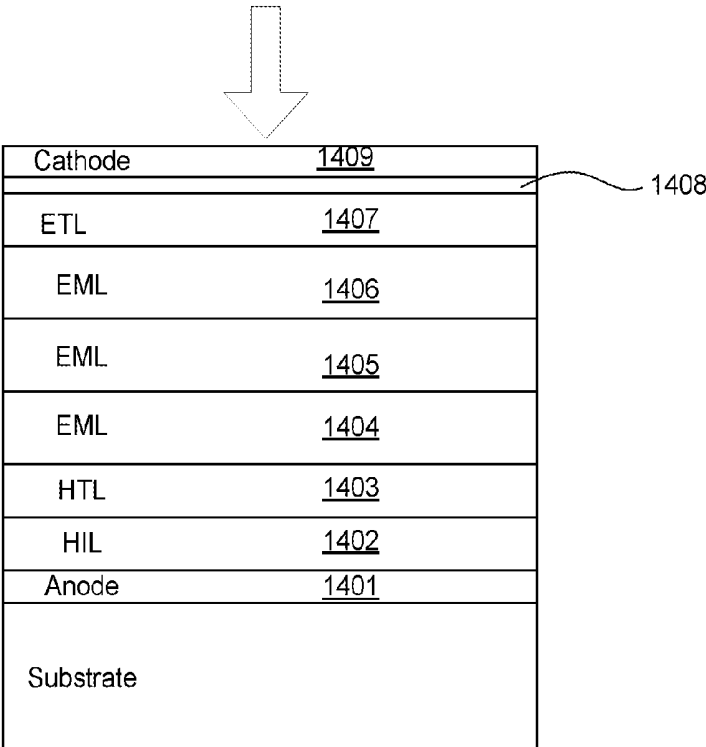

FIG. 14I

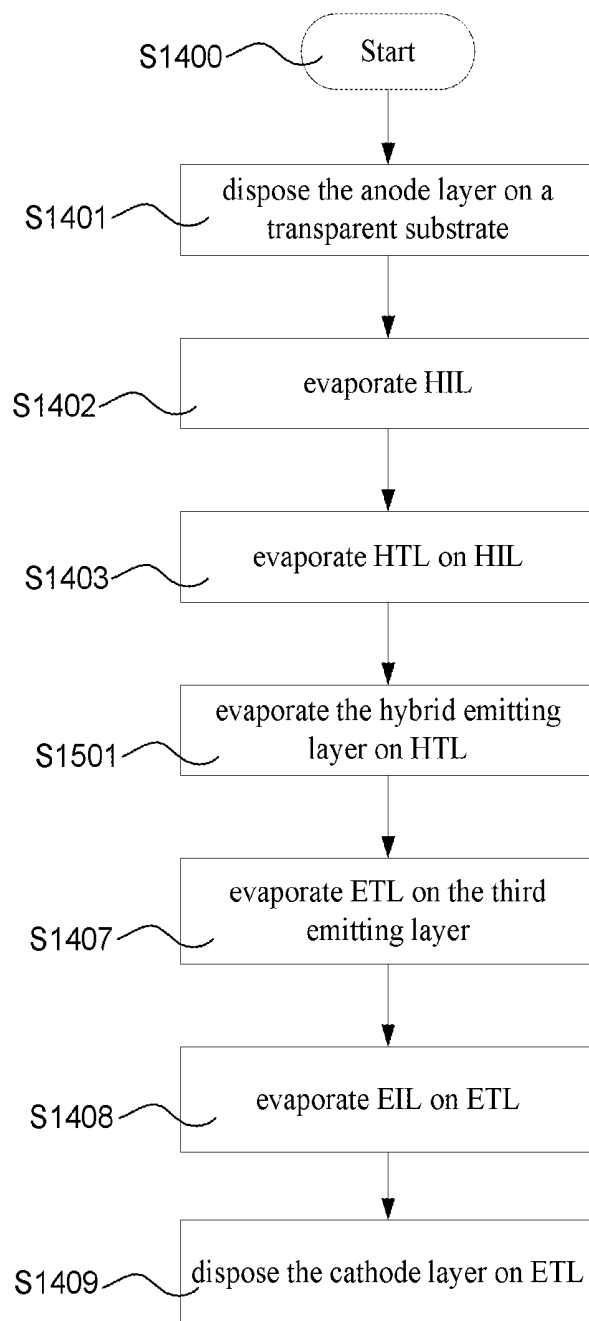

FIG. 15

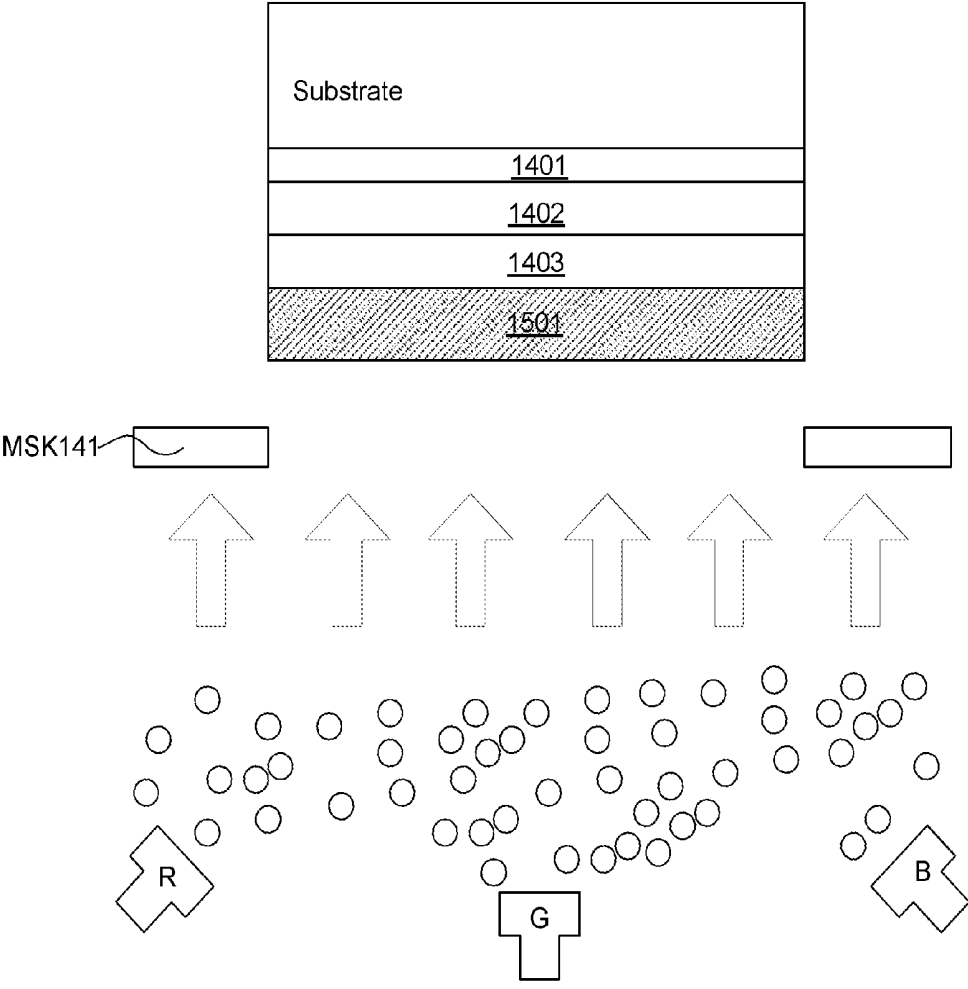

FIG. 15A

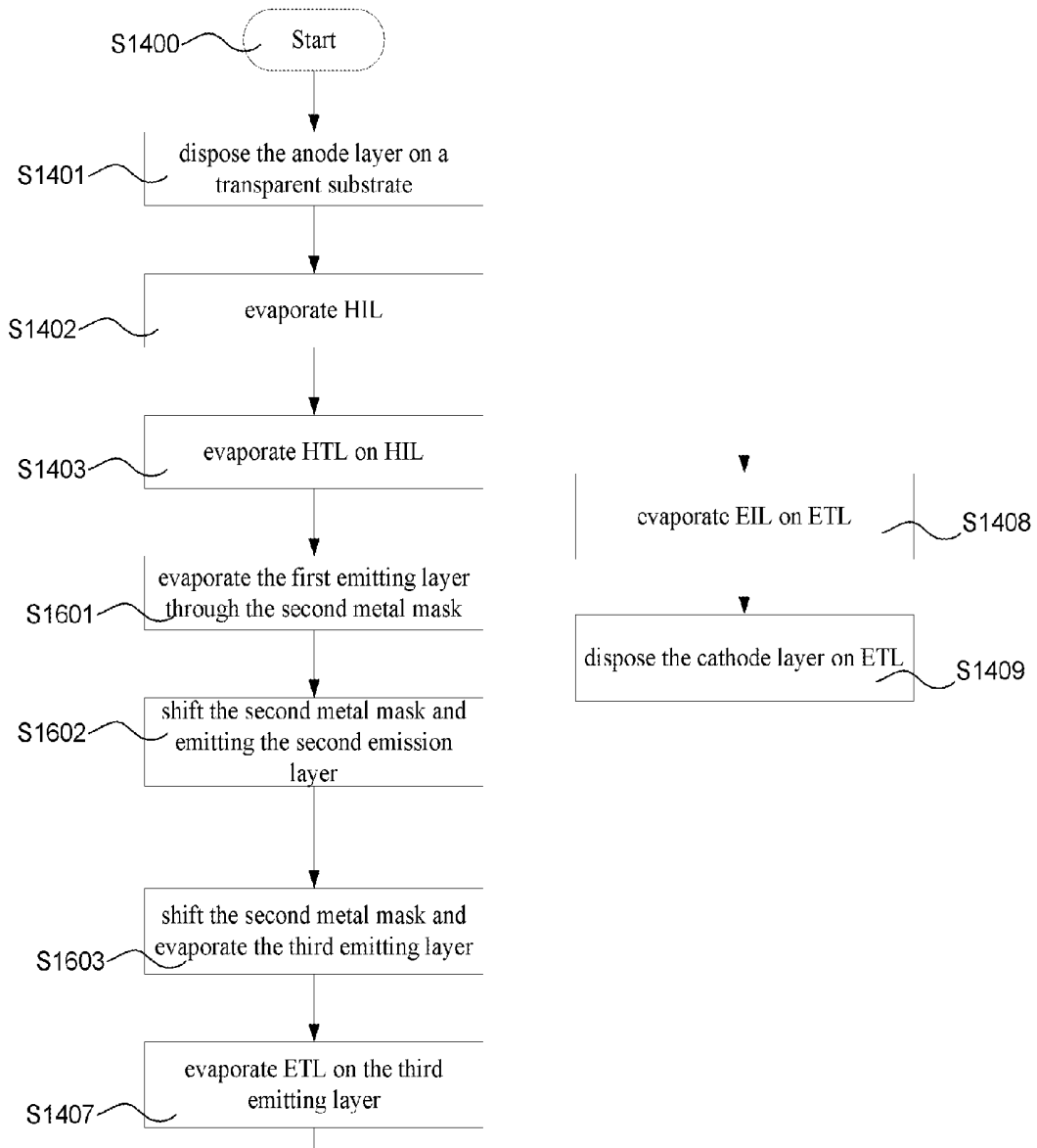

FIG. 16

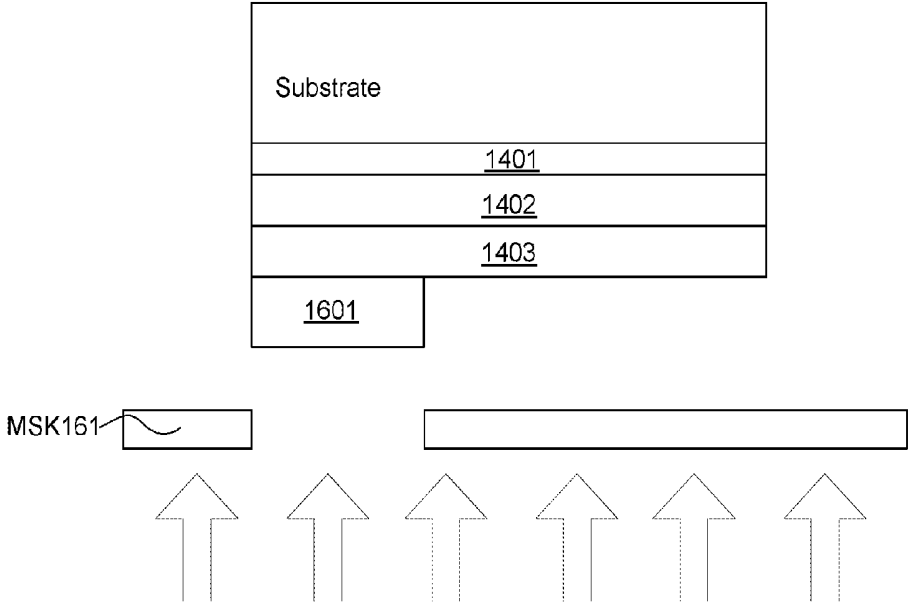

FIG. 16A

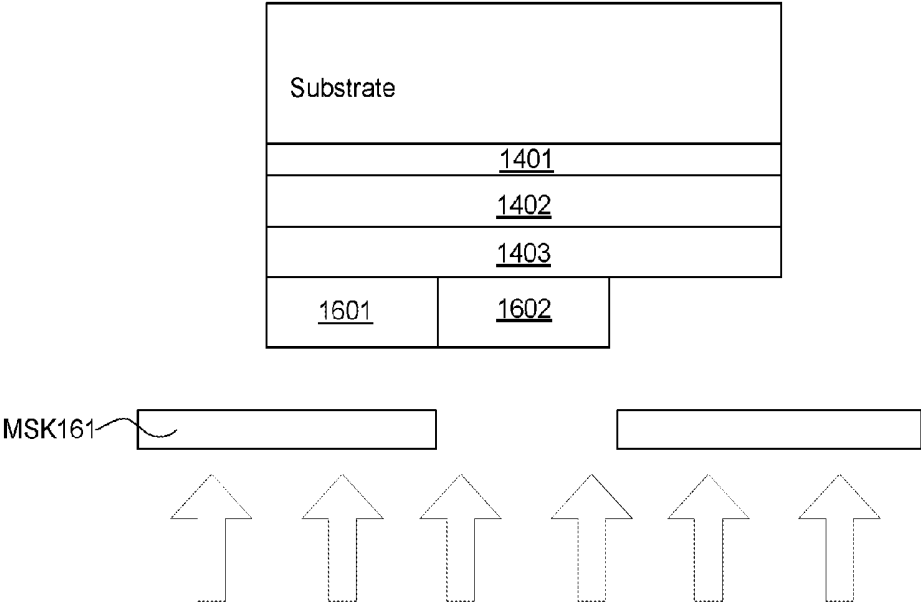

FIG. 16B

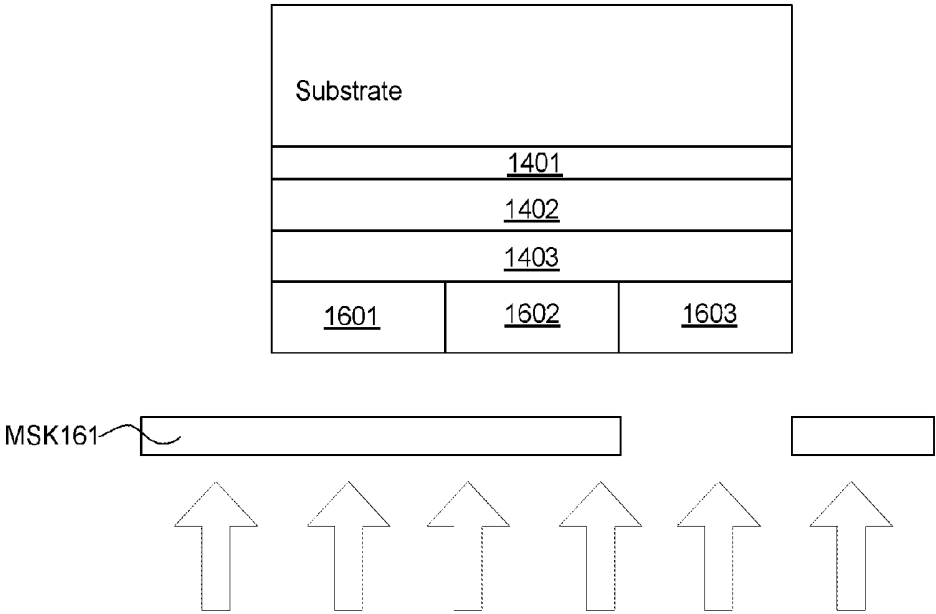

FIG. 16C

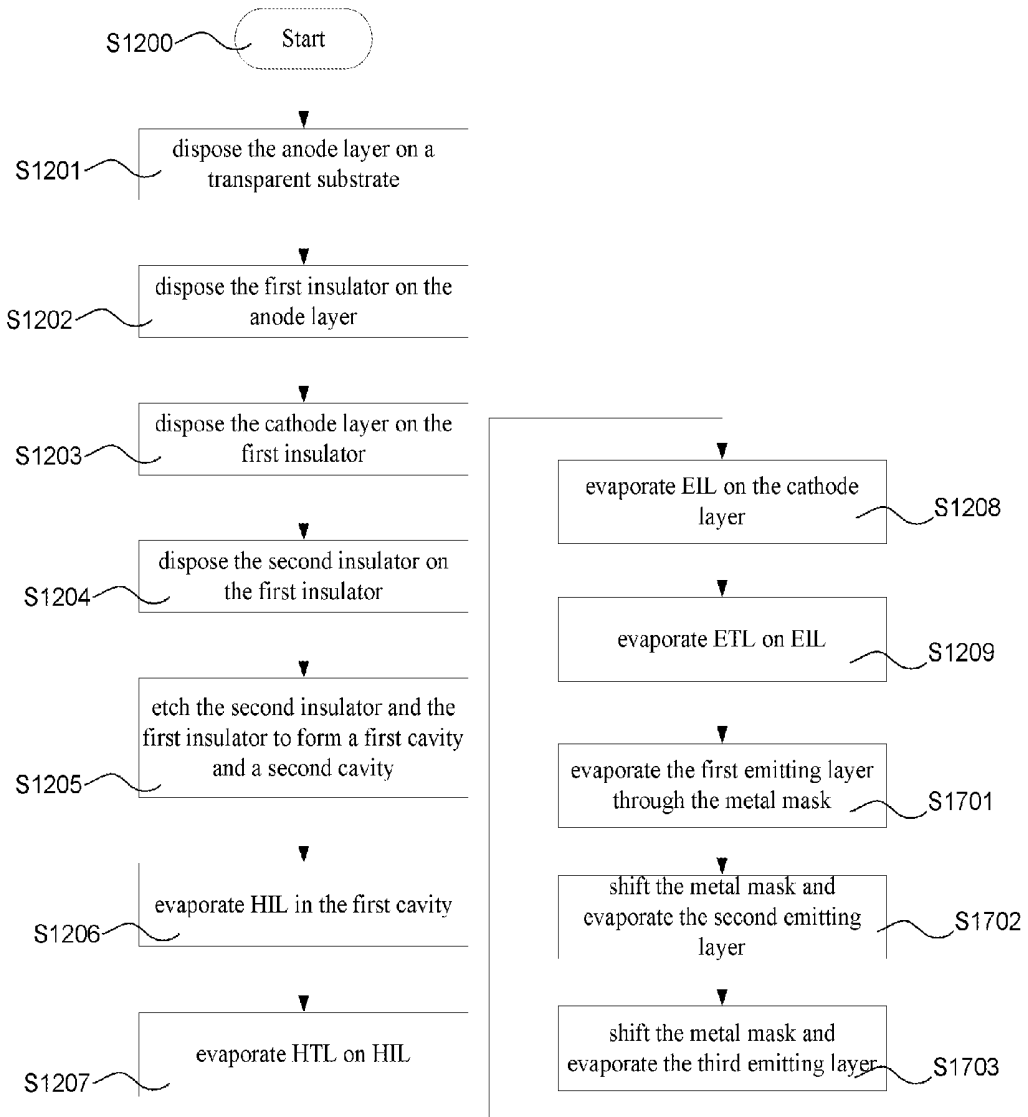

FIG. 17

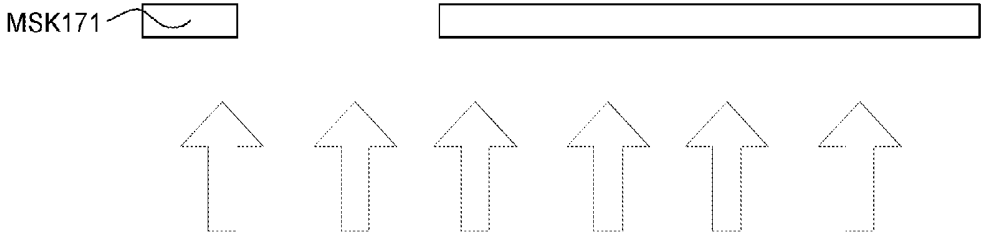
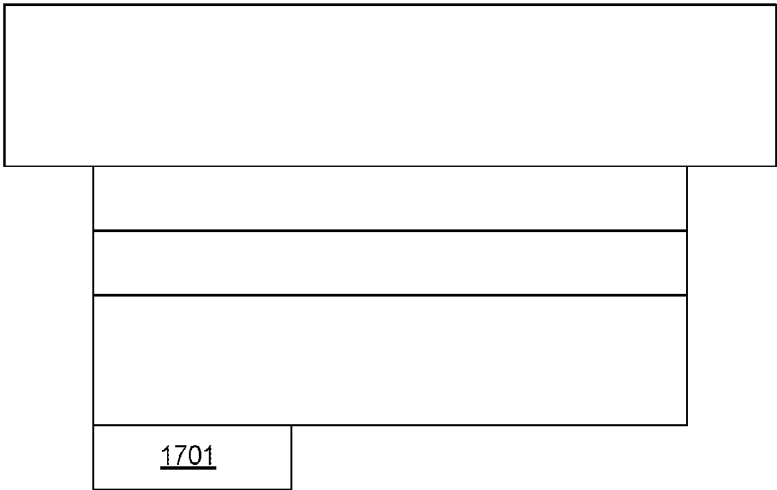

FIG. 17A

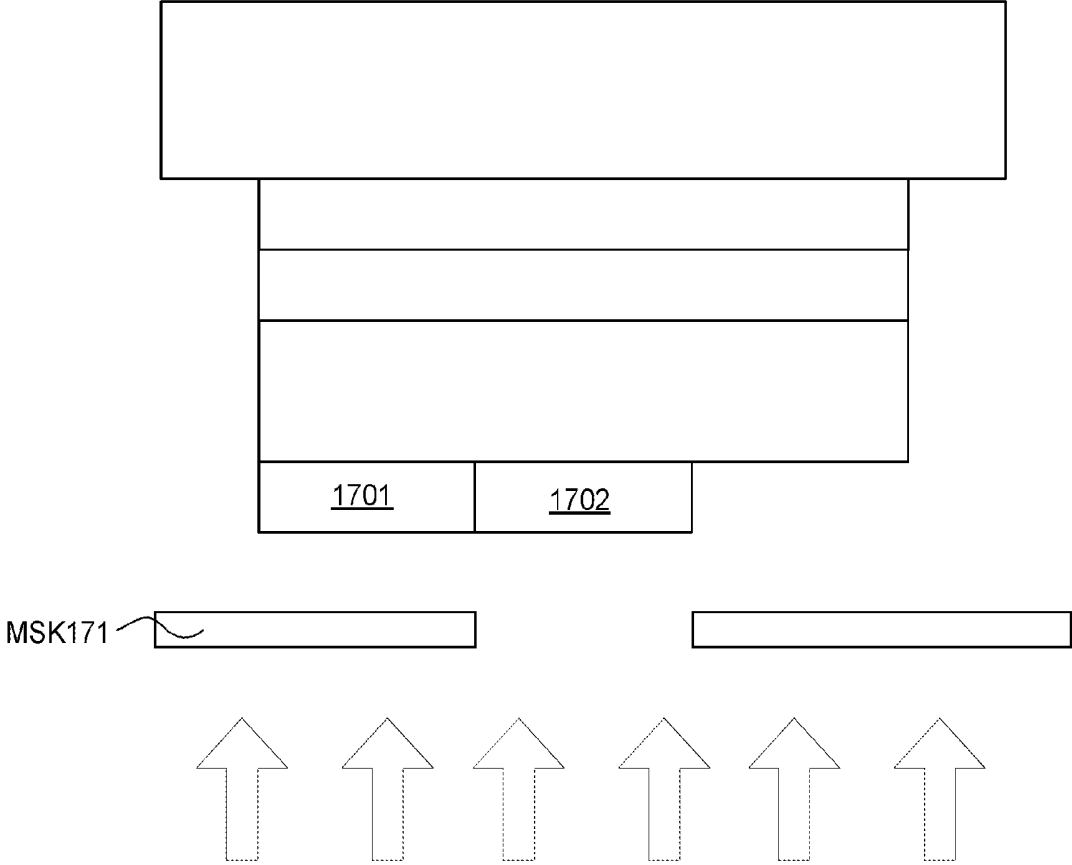

FIG. 17B

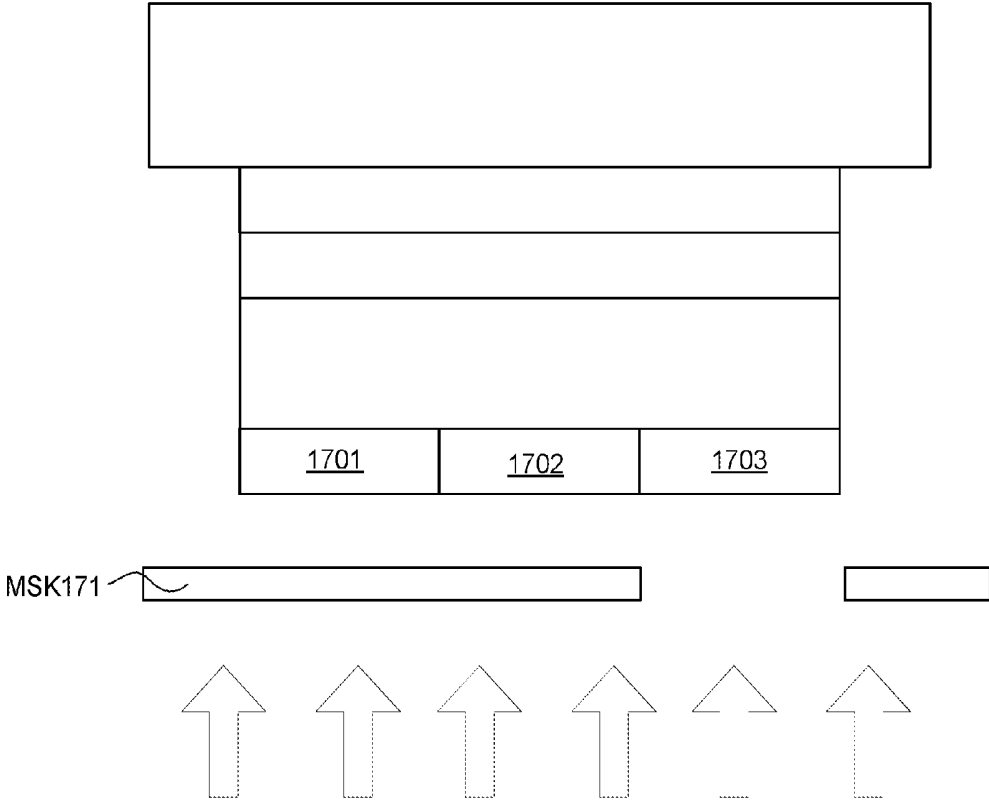

FIG. 17C

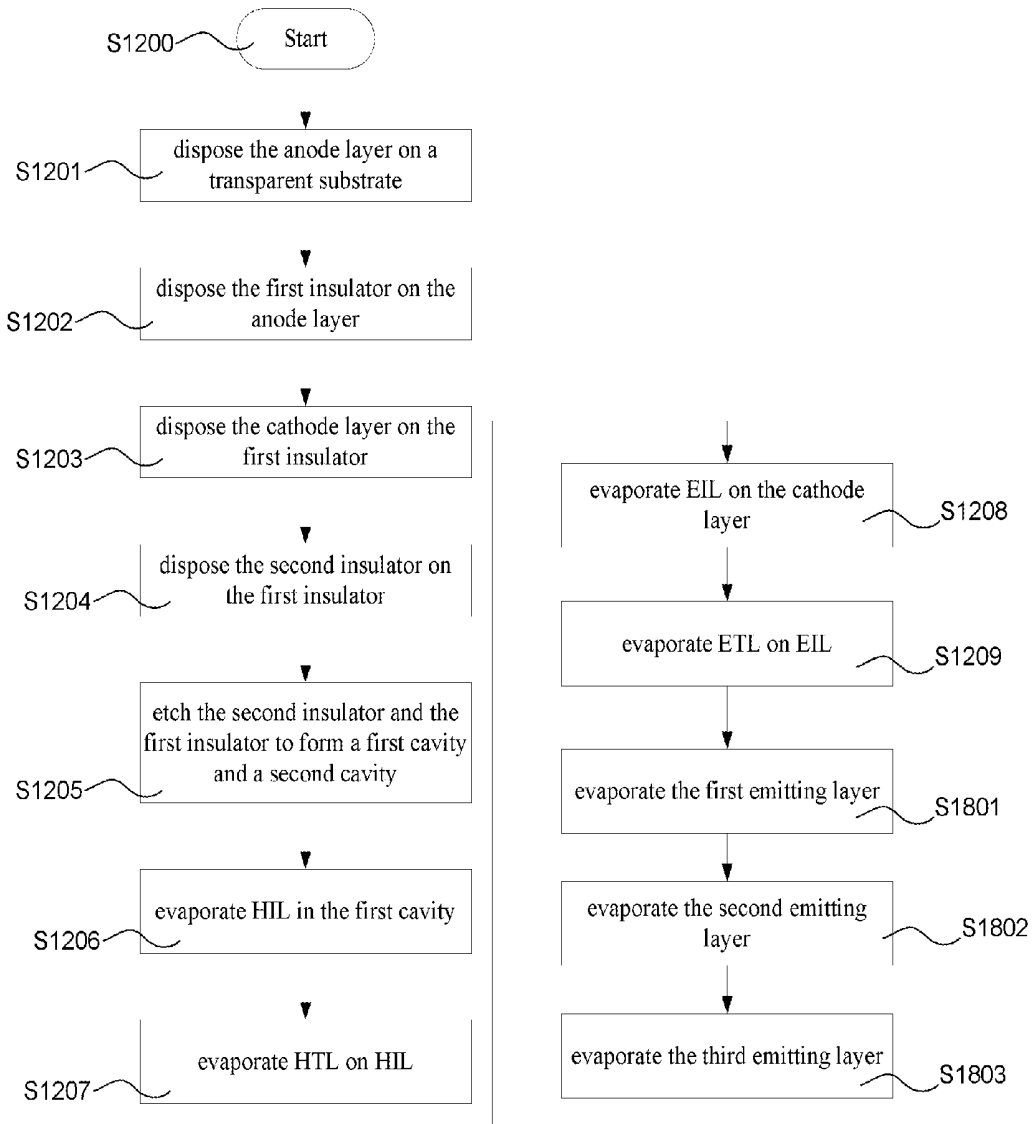

FIG. 18

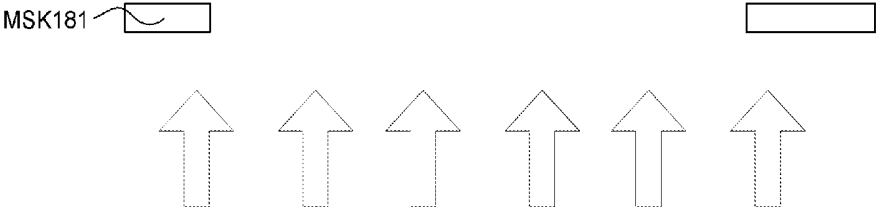
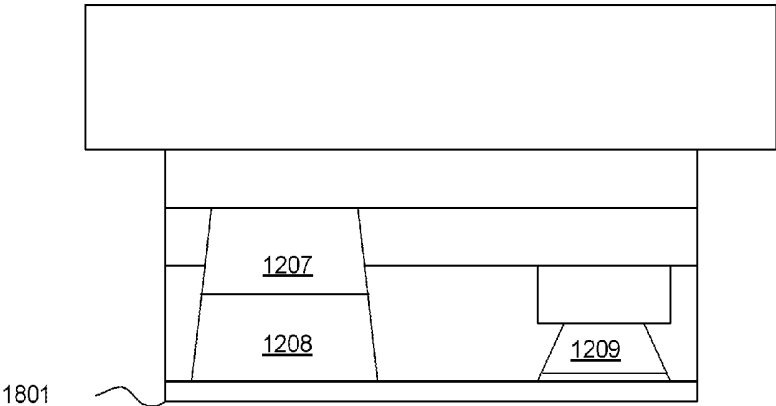

FIG. 18A

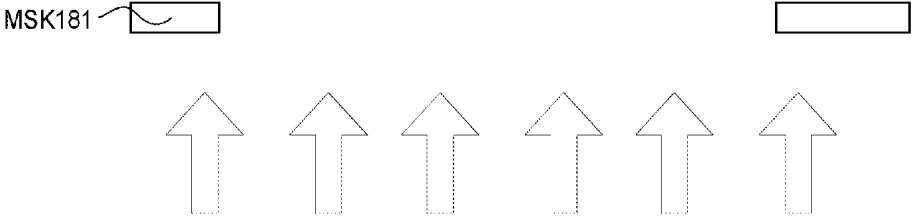
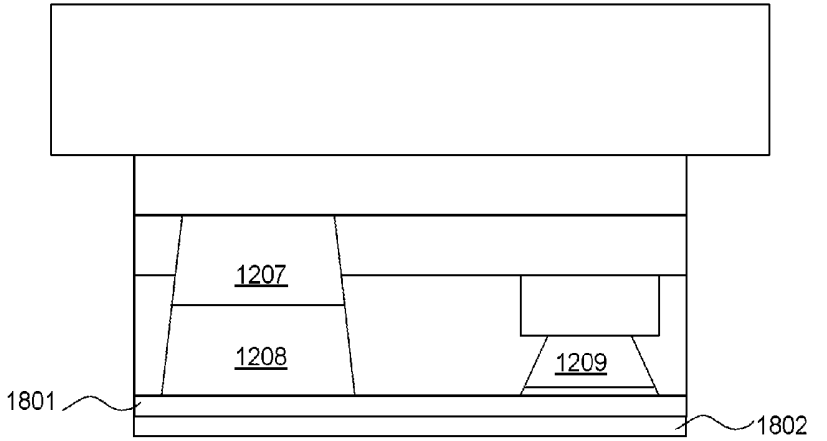

FIG. 18B

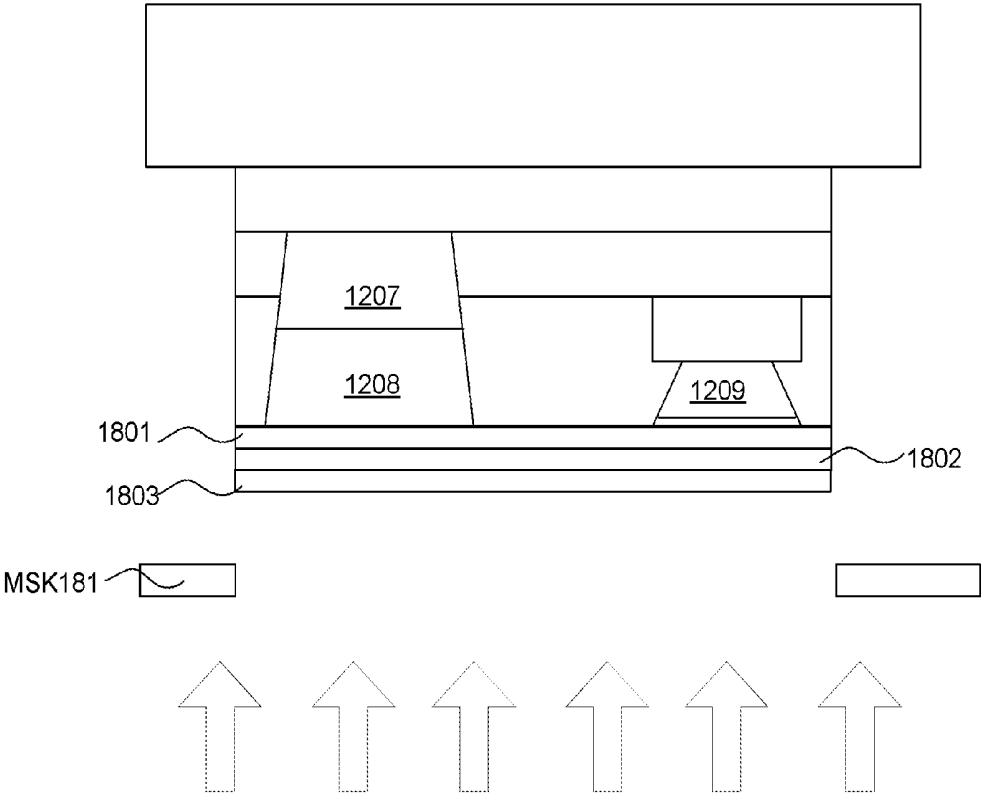

FIG. 18C

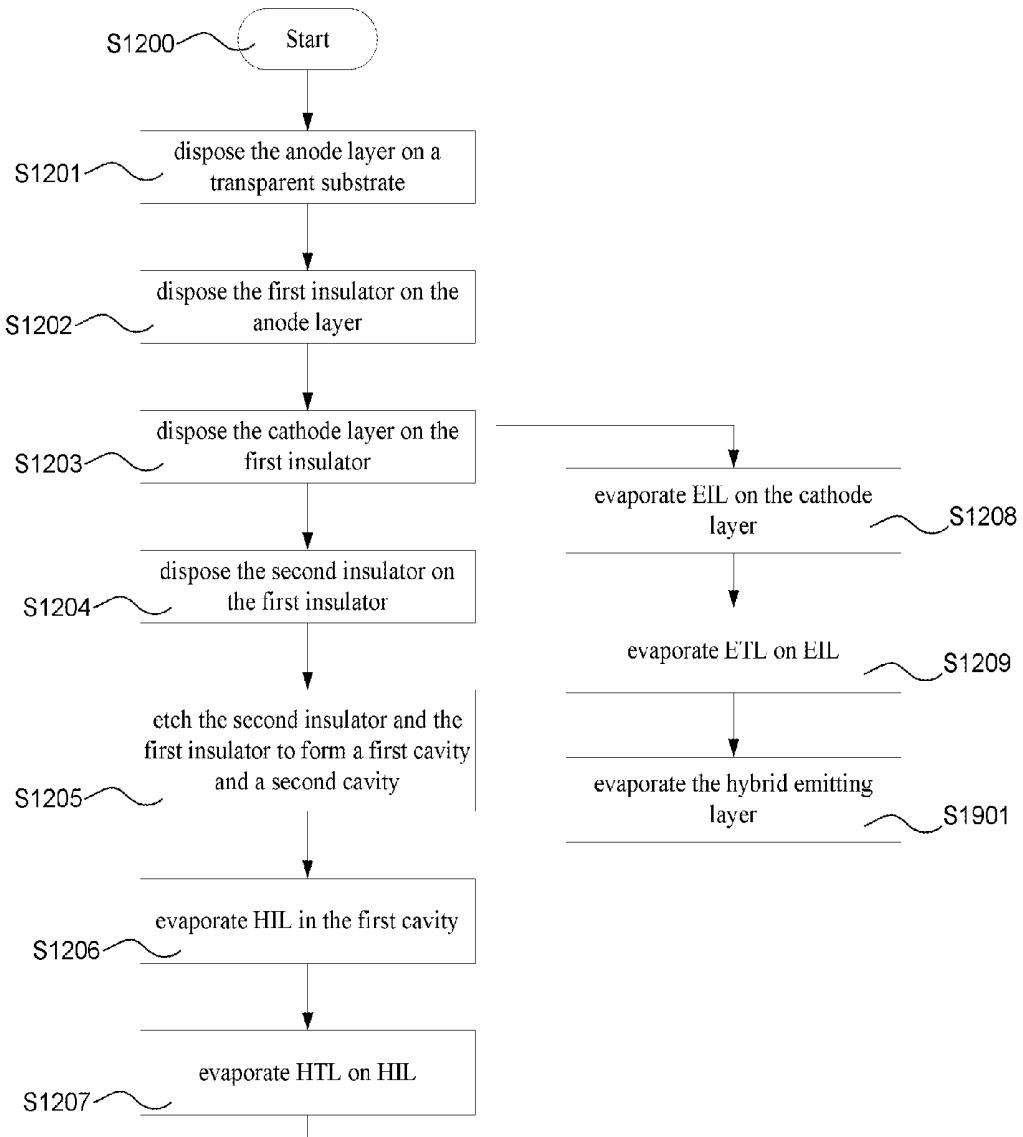
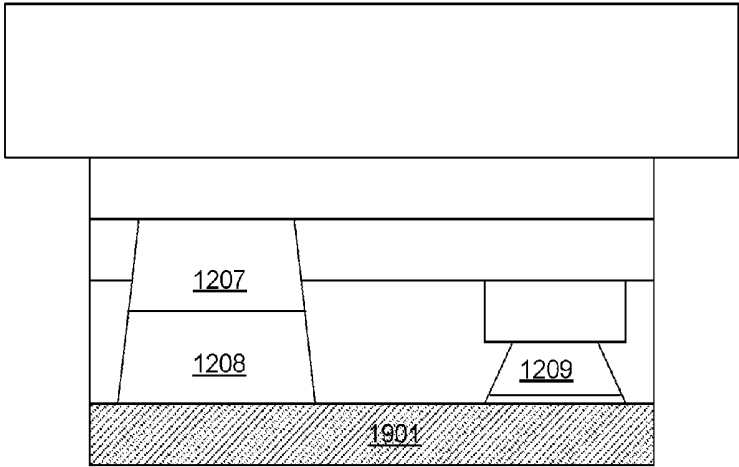
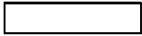

FIG. 19



MSK181 



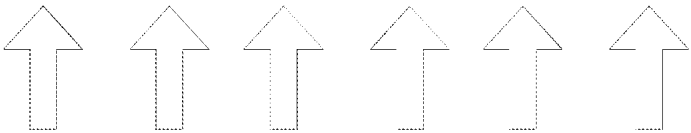

FIG. 19A

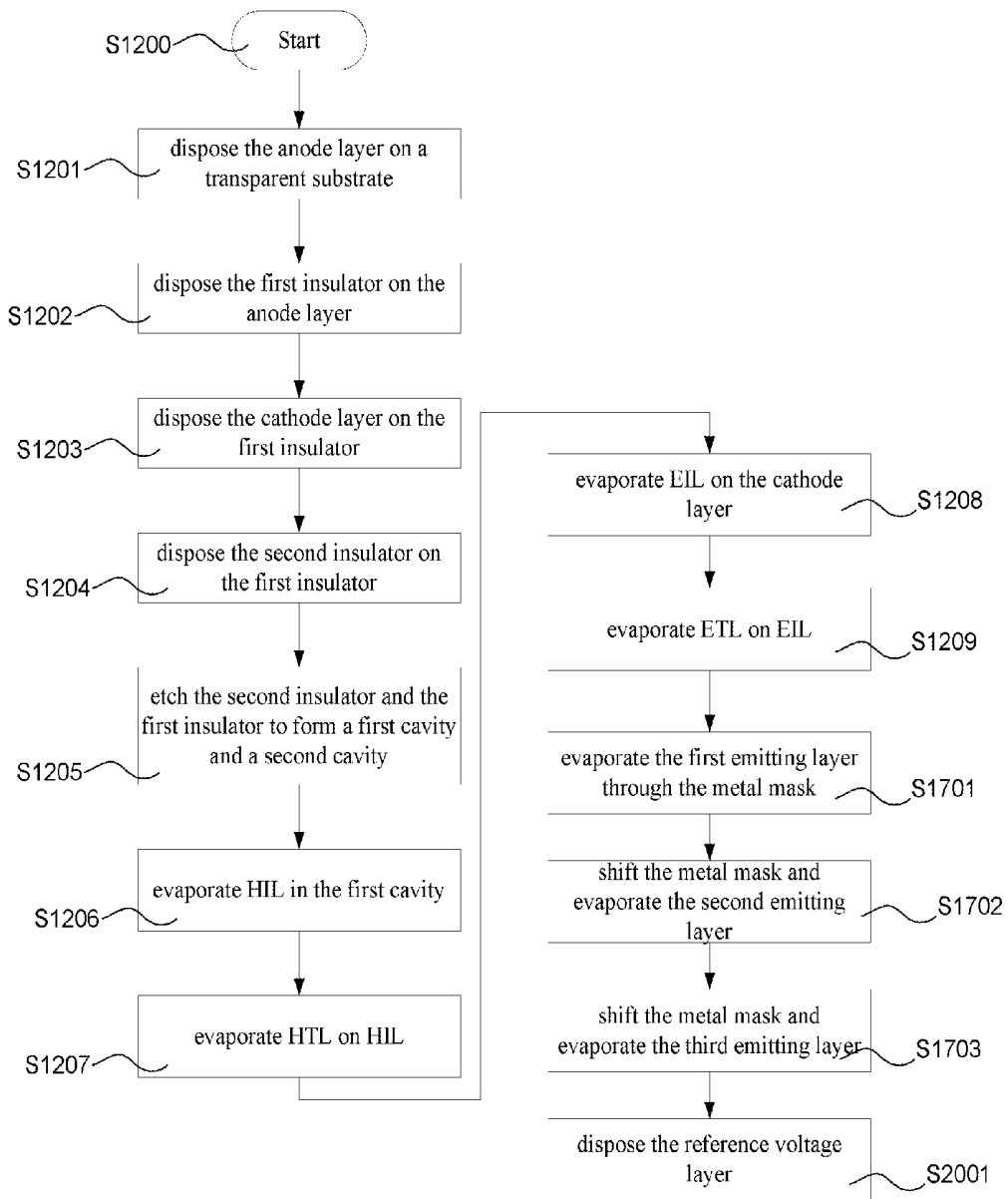

FIG. 20

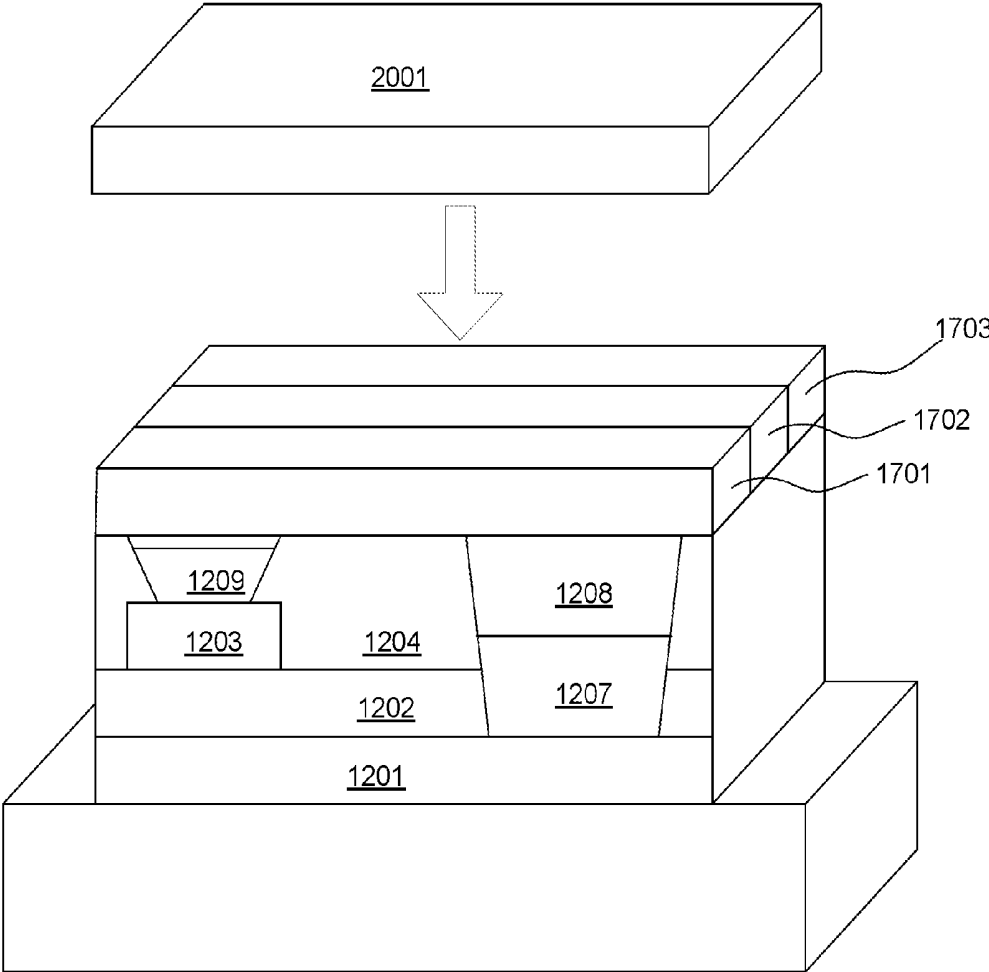

FIG. 20A

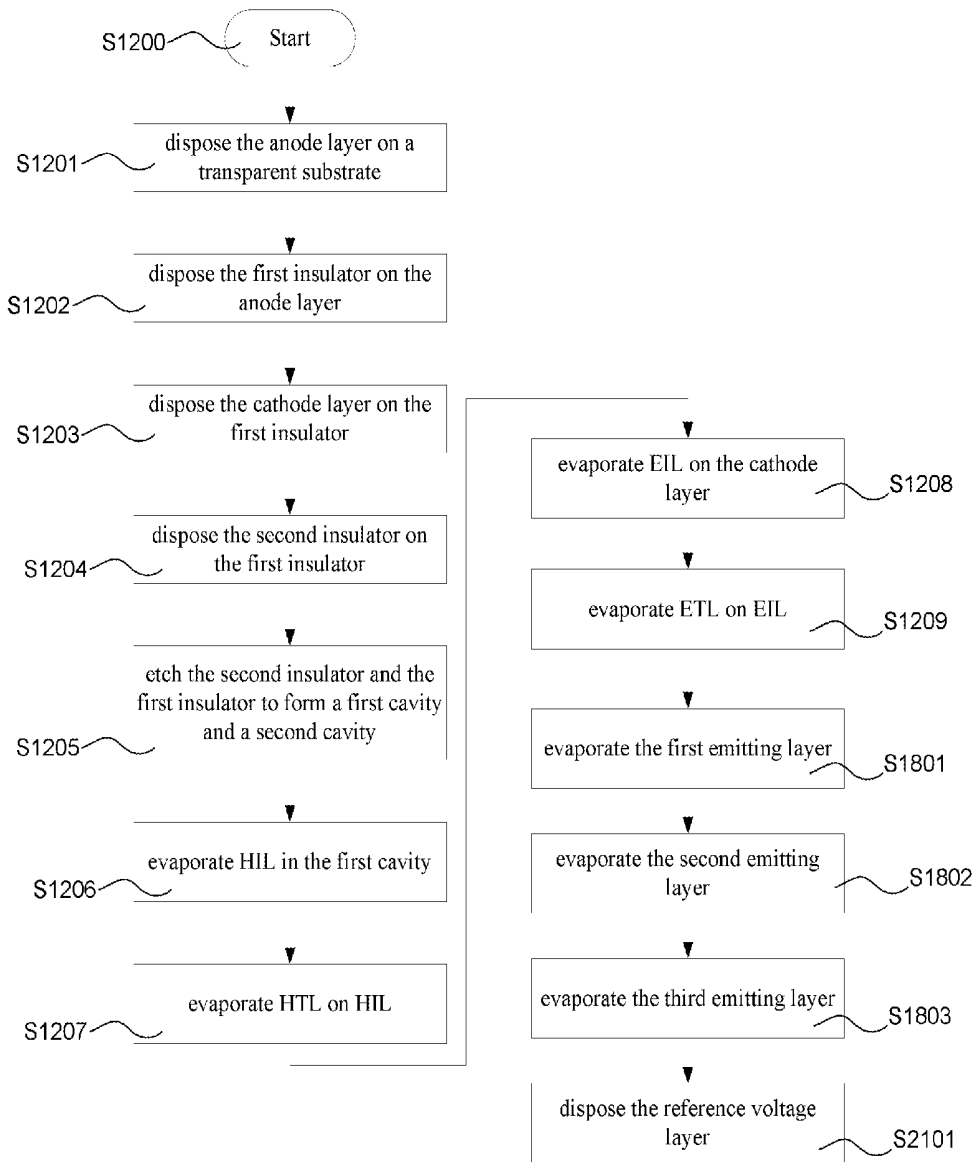

FIG. 21

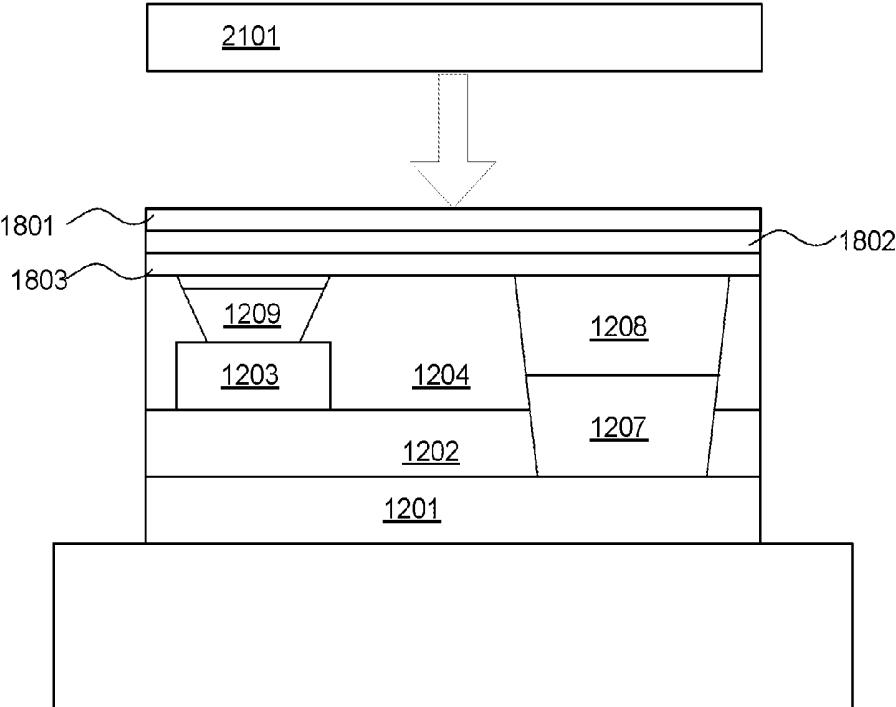

FIG. 21A

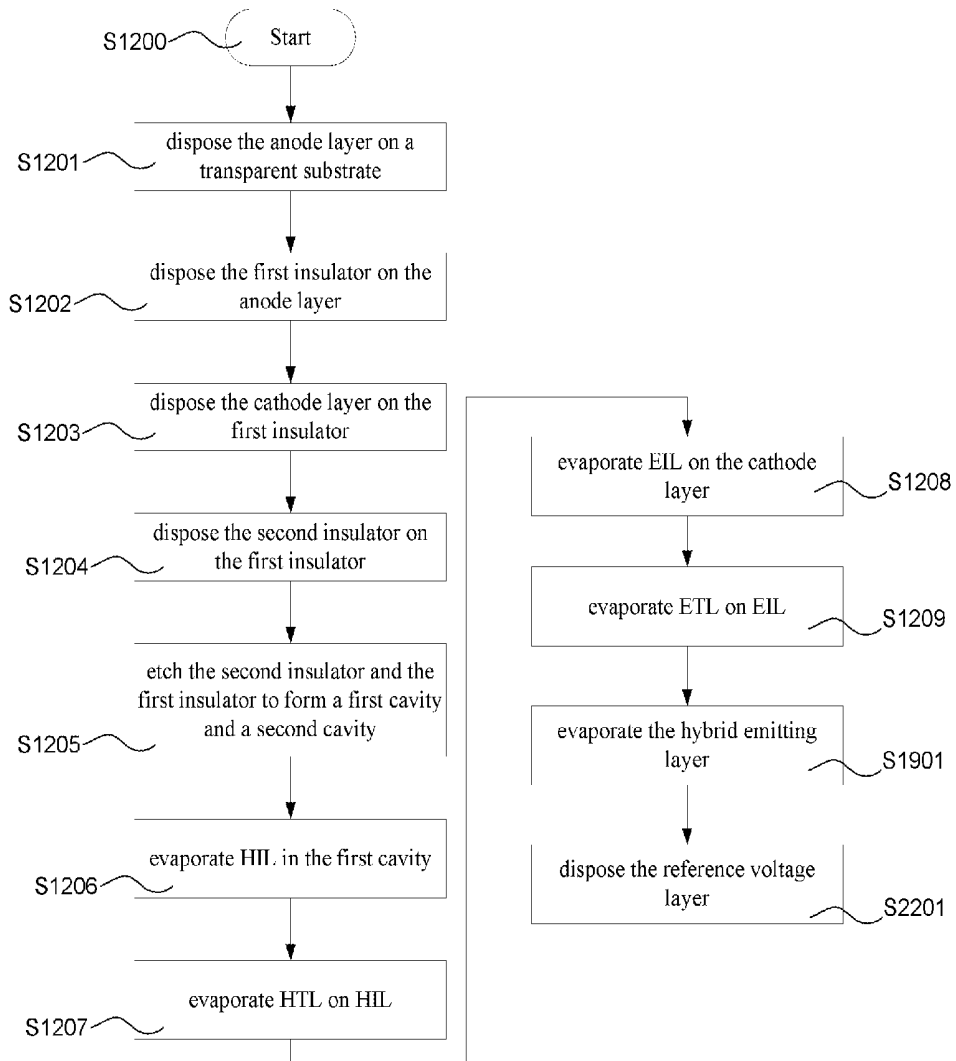

FIG. 22

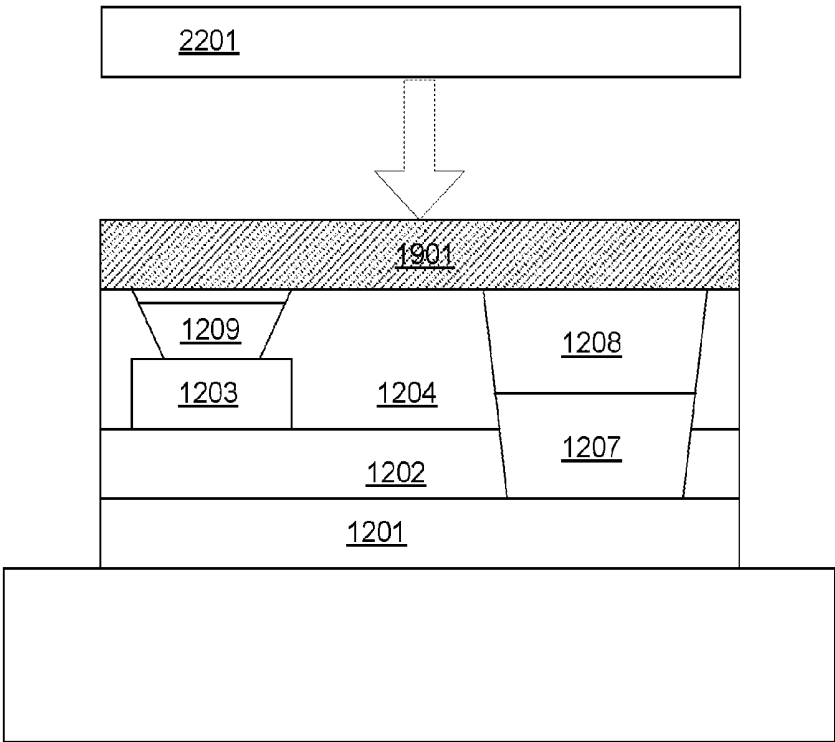

FIG. 22A

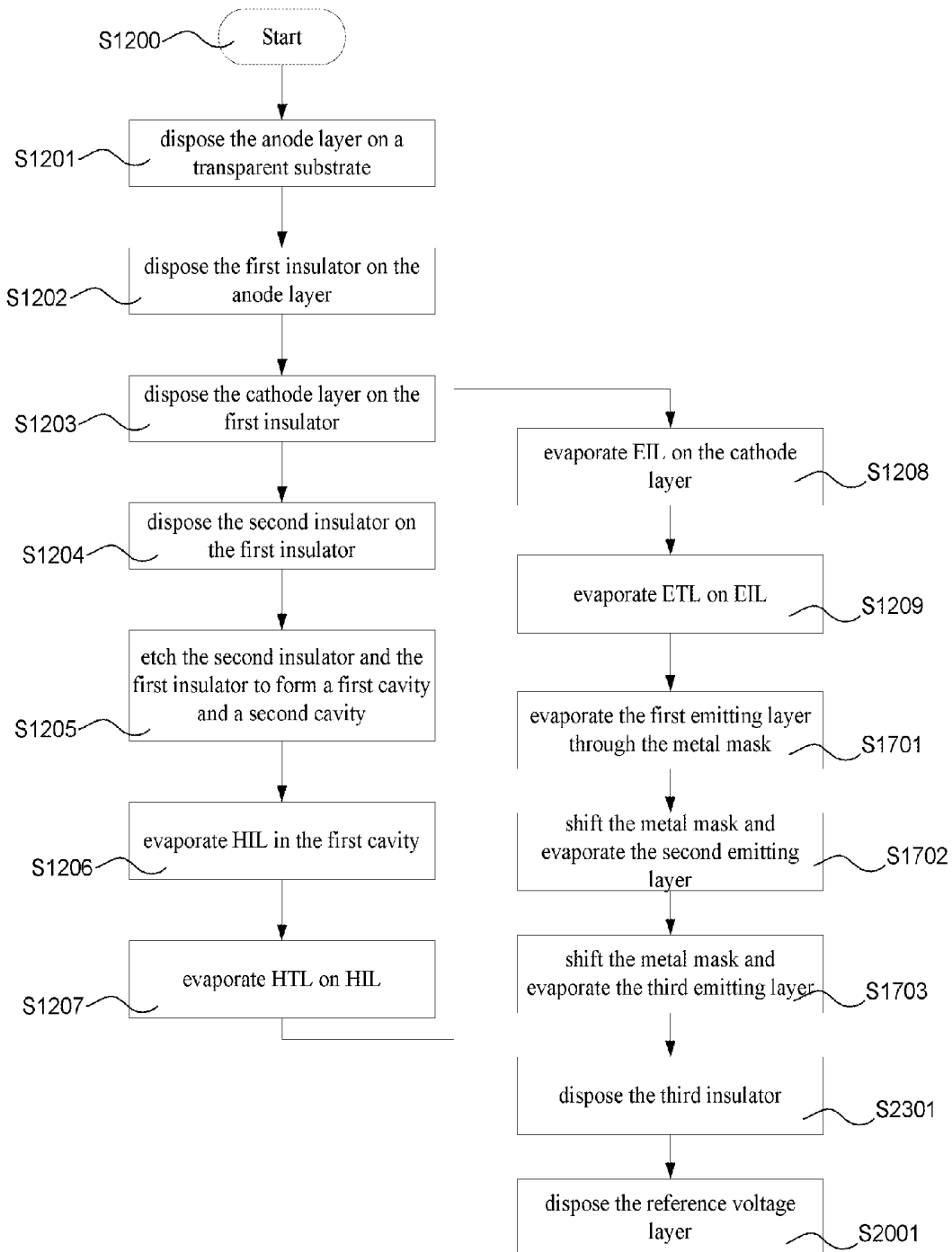

FIG. 23

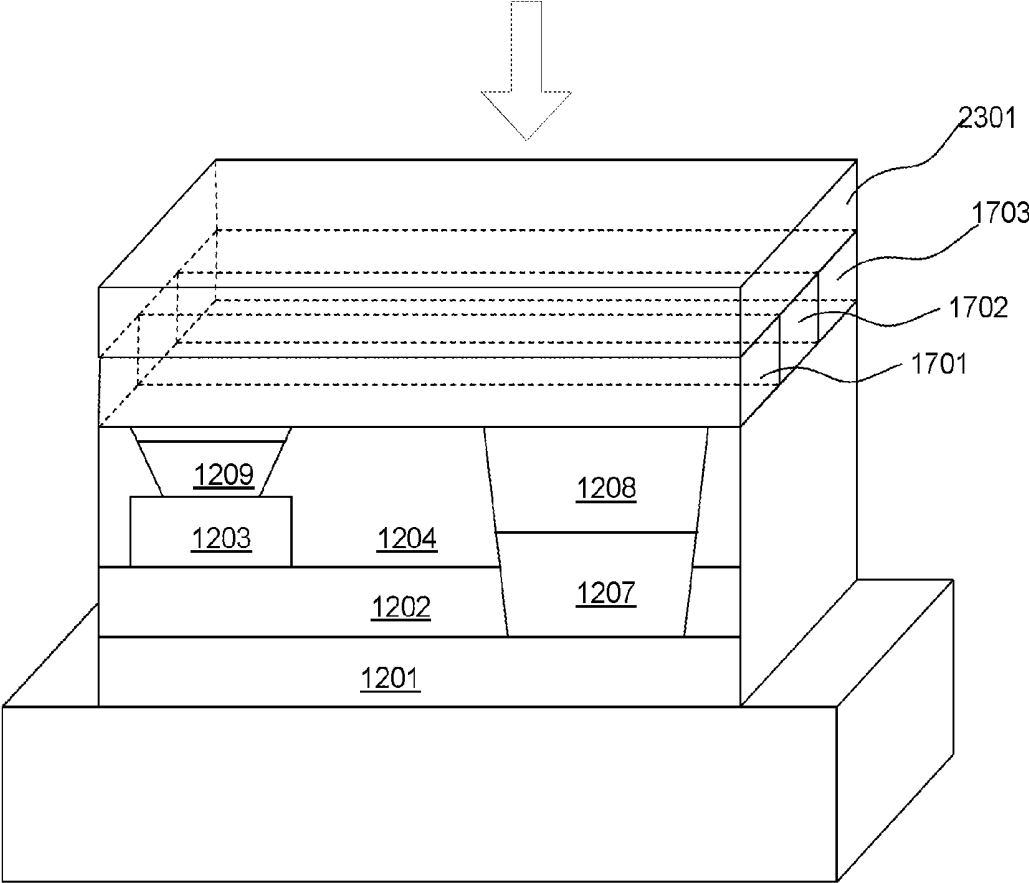

FIG. 23A

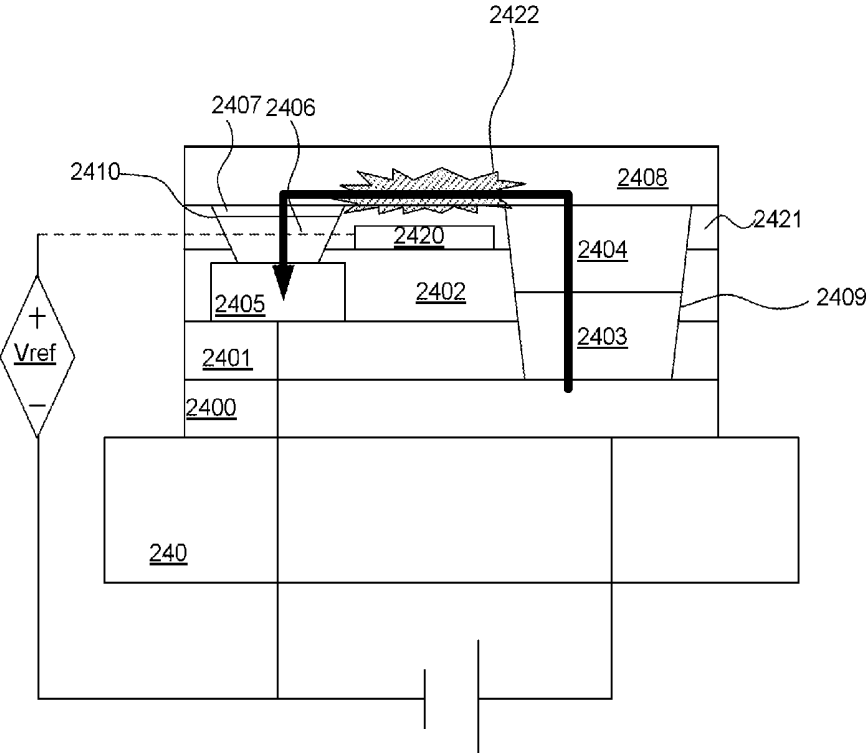

FIG. 24

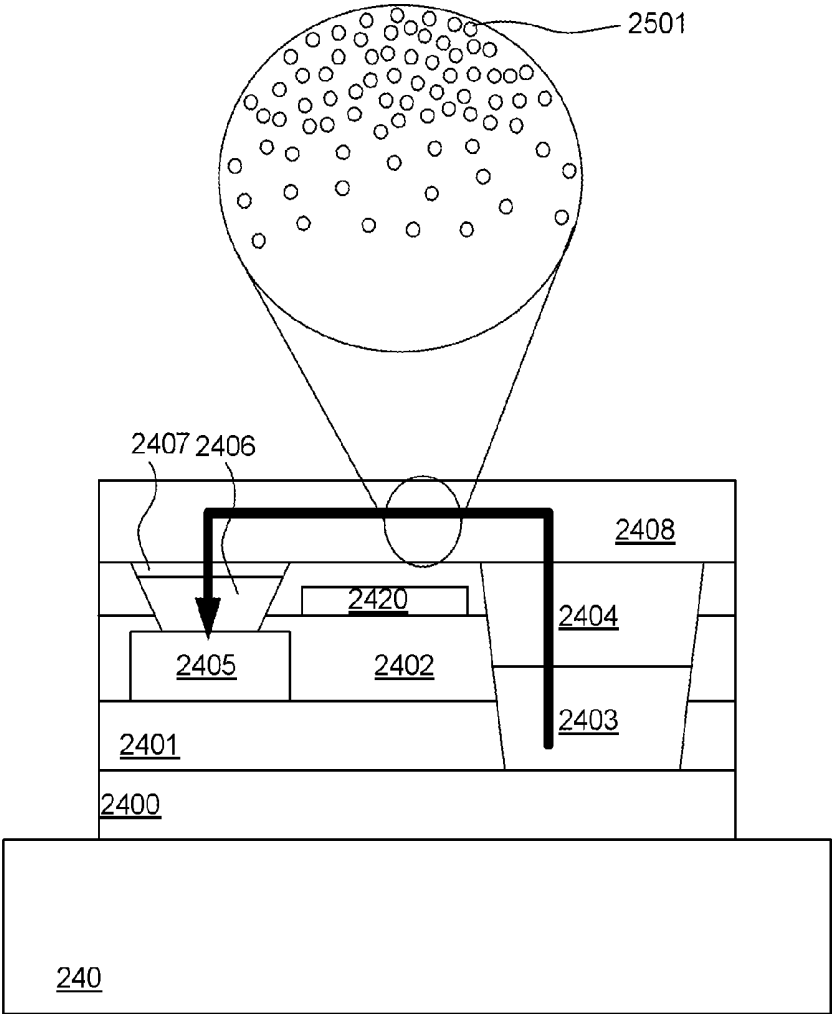

FIG. 25

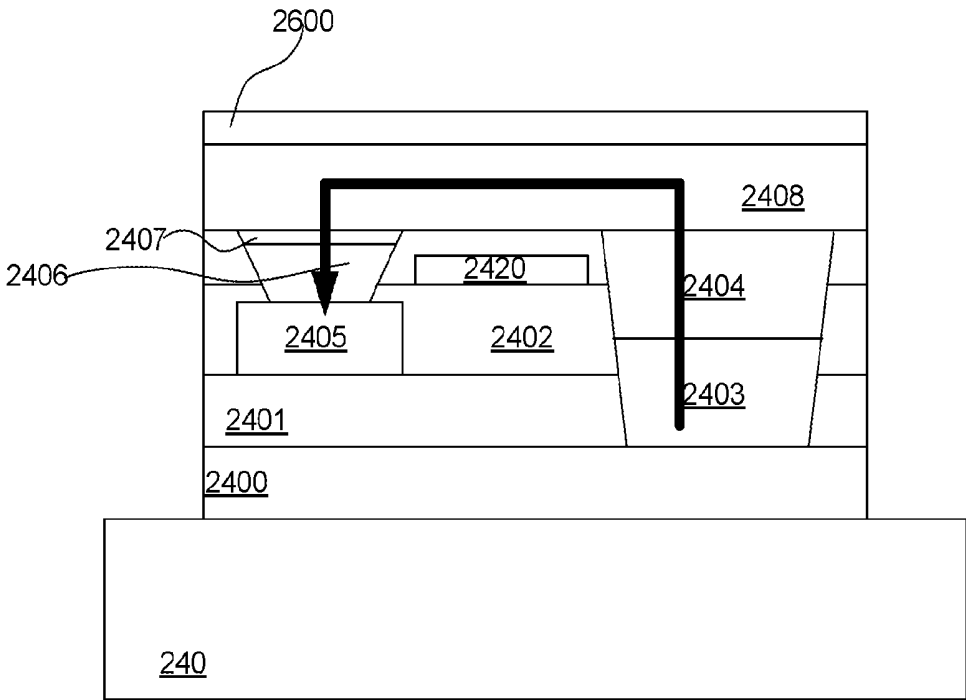

FIG. 26

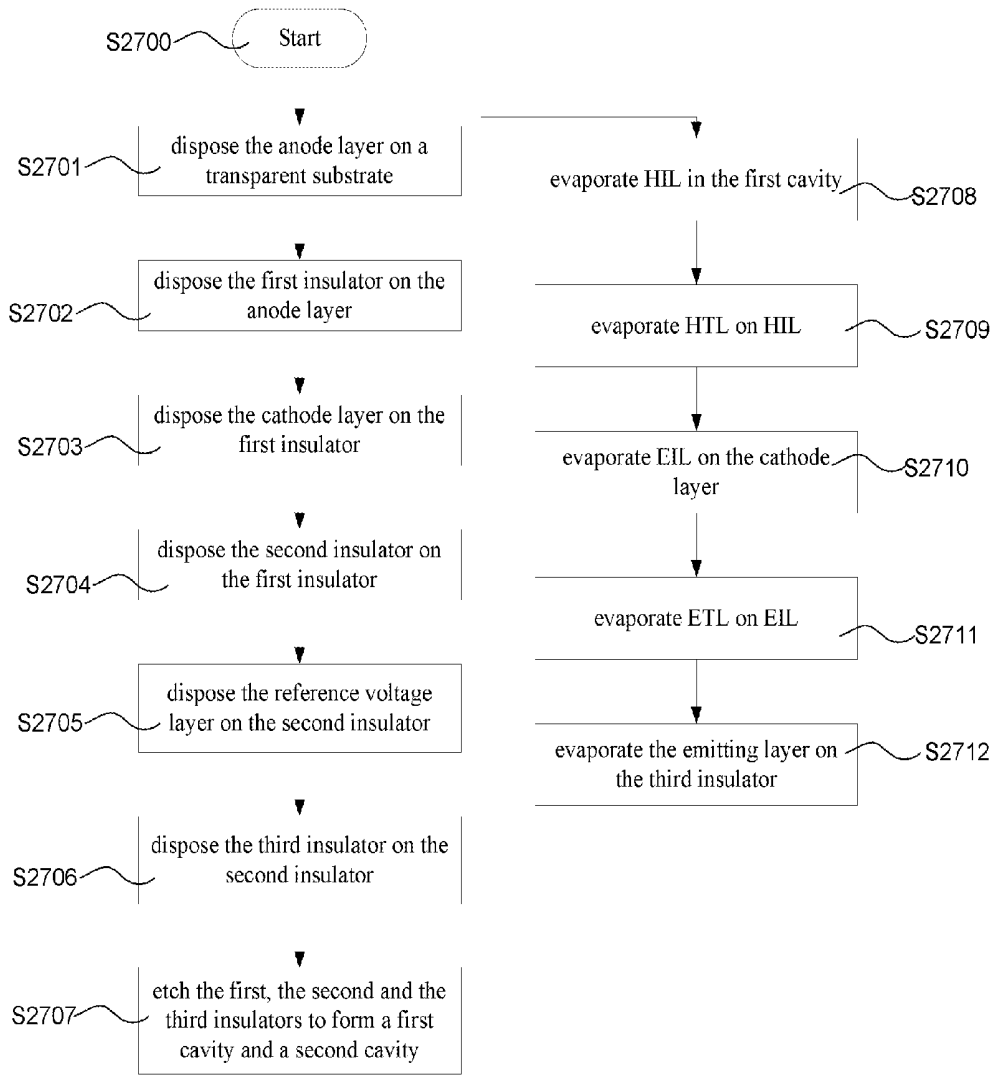

FIG. 27

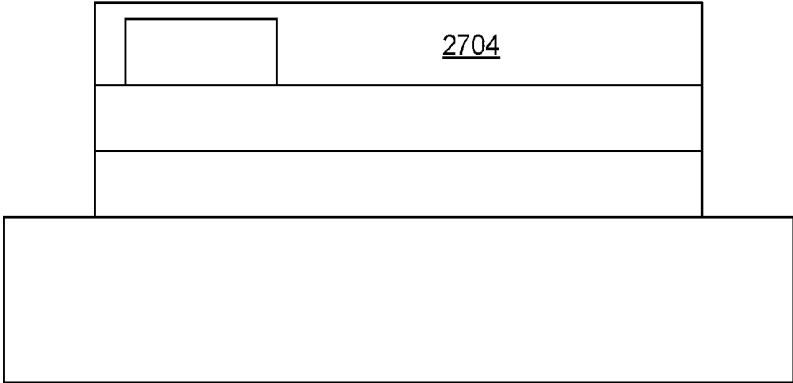

FIG. 27A

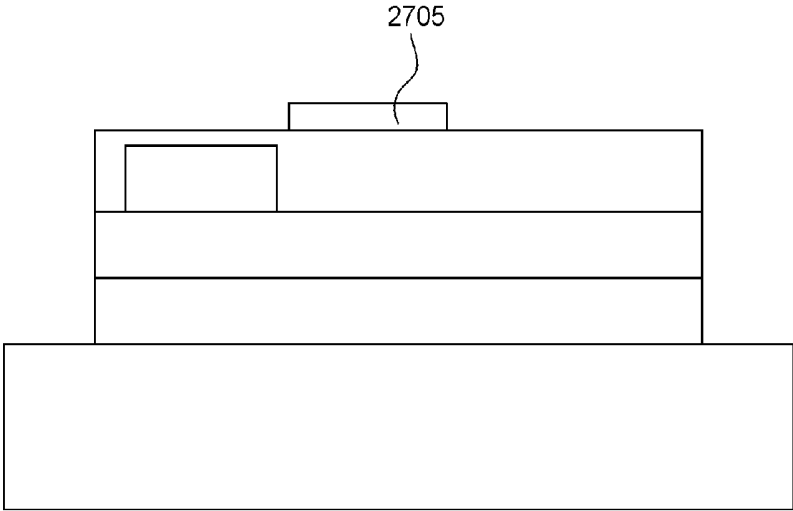

FIG. 27B

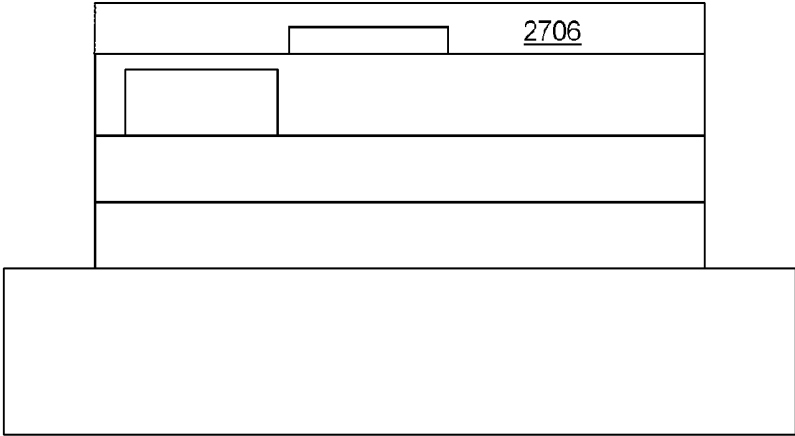

FIG. 27C

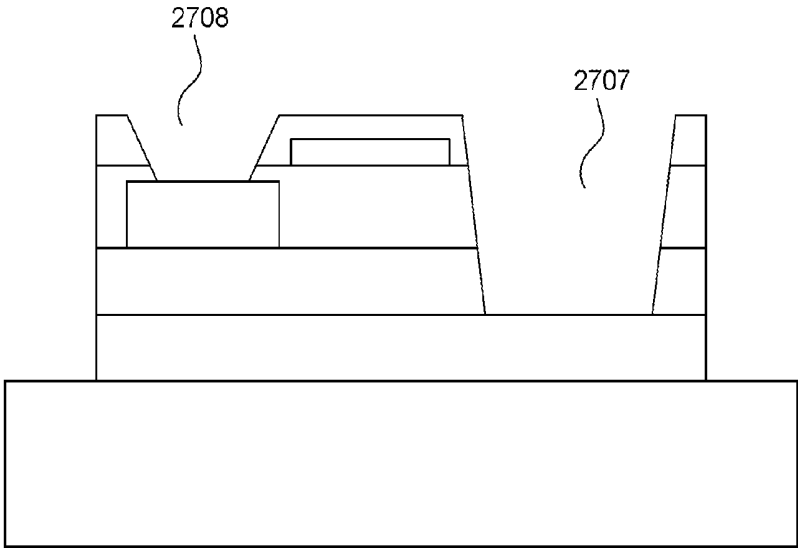

FIG. 27D

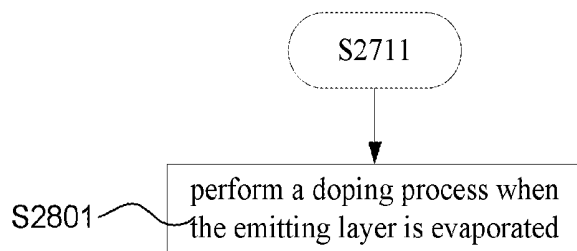

FIG. 28

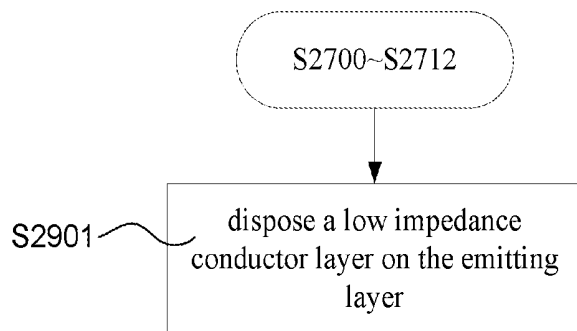

FIG. 29

**ORGANIC LIGHT-EMITTING DIODE PANEL
AND MANUFACTURING METHOD USING
THE SAME**

BACKGROUND OF THE INVENTION

[0001] This application claims priorities of No. 105133678 filed in Taiwan R.O.C. on Oct. 19, 2016 and No. 106121905 filed in Taiwan R.O.C. on Jun. 30, 2017 under 35 USC 119, the entire content of which is hereby incorporated by reference.

FIELD OF THE INVENTION

[0002] The present invention relates to the technology of an organic light-emitting diode, and more particularly, to an organic light-emitting diode panel and a manufacturing method thereof.

DESCRIPTION OF THE RELATED ART

[0003] The conventional organic light-emitting diode (OLED) device has a vertical stacked layer of the organic material layers by evaporating process as shown in FIG. 1. FIG. 1 illustrates a structure of the current OLED device. Referring to FIG. 1, the OLED device includes a glass substrate 100, an anode layer 101, a hole injection layer (HIL) 102, a hole transport layer (HTL) 103, an organic emitting layer (EML) 104, an electron transport layer (ETL) 105, an electron injection layer (EIL) 106 and a cathode layer 107. The total thickness of those stacked layers is also marked in FIG. 1.

[0004] In the prior art, there are drawbacks appear as follows:

[0005] 1. Because the organic materials are very thin, about 1000~2000 Å in total, the circuits between the anode and cathode would be easily short circuit. It causes dot defect of the OLED display, unusual high current and the reduction of the production yield.

[0006] 2. Because the low aperture ratio of the glass substrate of the thin film transistor, the bottom emission OLED has insufficient brightness.

[0007] 3. The top emission OLED requires a high conduction and a high transparent material to serve as cathode. However, the cathode material is generally made of metal. If the cathode metal is too thin, its impedance is too high. If the cathode metal is too thick, the luminous efficiency would be reduced.

[0008] FIG. 2 illustrates a schematic depicting a current white OLED device. The 201 is the equivalent circuit of the white OLED device. In FIG. 2, the white OLED device is composed of red, green and blue OLED devices stacked in vertical direction. Because three OLED devices 201 are series, the driving voltage would be increased several times.

[0009] Moreover, the luminous efficiency of OLED materials depends on magnitude of the current flowing through the emitting layer, and the currents required by different color materials of the emitting layer to reach the best luminous efficiency are various. The currents flowing through the emitting layer in series structure (vertical stack) of the white OLED are the same, and it is difficult to find and employ a current value suitable for all the color emitting materials with their best luminous efficiency. Thus, the color shift of the white light occurs easily. Furthermore, in the manufacture of traditional tandem organic light emitting diodes, the organic materials must be formed by evaporating

layer by layer. The manufacturing cost would be increased as number of stacked layers increases.

SUMMARY OF THE INVENTION

[0010] An objective of the present invention is to provide an organic light-emitting diode panel and a manufacturing method thereof to change the structure of OLED to achieve high luminous efficiency, production yield improvement and reduction in circuit complexity.

[0011] In view of this, the present invention provides an organic light-emitting diode panel, which includes at least a pixel. The pixel includes an anode layer, a first insulator, a cathode layer, a second insulator, a hole injection layer, a hole transport layer, an electron injection layer, an electron transport layer, an emitting layer and a reference voltage layer. The anode layer is disposed on a transparent substrate. The first insulator is disposed on the anode layer. The cathode layer is disposed on the first insulator. The second insulator is disposed on the anode layer and has a first cavity and a second cavity, wherein a bottom of the second cavity exposes the cathode layer and a bottom of the first cavity exposes the anode layer. The hole injection layer is disposed in the first cavity and disposed on the anode layer. The hole transport layer is disposed in the first cavity and disposed on the hole injection layer. The electron injection layer is disposed in the second cavity and disposed on the cathode layer. The electron transport layer is disposed in the second cavity and disposed on the electron injection layer. The emitting layer is disposed on the second insulator. The reference voltage layer is disposed on a side of the emitting layer, wherein a three-terminal OLED is formed by the anode layer, the cathode layer and the reference voltage layer.

[0012] In the organic light-emitting diode panel according to the preferred embodiment of the present invention, the pixel further includes a thin film insulator disposed between the reference voltage layer and the emitting layer such that its operation is similar to the MOSFET. In a preferred embodiment of the present invention, the pixel further includes a thin film transistor and a capacitor. The gate terminal of the thin film transistor is coupled to a scan line, the first source/drain terminal of the thin film transistor is coupled to a data line, the second source/drain terminal of the thin film transistor is coupled to the reference voltage layer. The first terminal of the capacitor is coupled to the second source/drain terminal of the thin film transistor, and the second terminal of the capacitor is coupled to a common voltage. Thus, the panel can be served as an active-matrix OLED panel.

[0013] In the organic light-emitting diode panel according to the preferred embodiment of the present invention, the voltage of the reference voltage layer is used to control a current from the anode layer to the cathode layer through the emitting layer, and a current path in the emitting layer. In addition, the emitting layer further includes a first color emitting material, a second color emitting material and a third color emitting material. The second color emitting material is disposed by a side of the first color emitting material, and the third color emitting material is disposed by a side of the second color emitting material. In this embodiment, these color emitting materials are arranged at the same level. The pixel emits the white light by mixing a first color light, a second color light and a third color light respectively emitting from the first color emitting material, the second

color emitting material and the third color emitting material. In another preferred embodiment, the emitting layer also includes a first color emitting material, a second color emitting material and a third color emitting material, and these color emitting materials are stacked vertically. That is, the second color emitting material is disposed on the first color emitting material, and the third color emitting material is disposed on the second color emitting material. In a preferred embodiment of the present invention, the pixel further includes a third insulator, disposed on the second insulator and covering the reference voltage layer.

[0014] The present invention further provides a manufacturing method for organic light-emitting diode panel. The manufacturing method includes: performing a sputtering process to form an anode layer on a transparent substrate; disposing a first insulator on the anode layer; disposing a cathode layer on the first insulator; disposing a second insulator on the first insulator; etching the first insulator and the second insulator to form a first cavity and a second cavity, wherein a bottom of the second cavity exposes the cathode layer; evaporating a hole injection layer in the first cavity, wherein the hole injection layer is disposed on the anode layer; evaporating a hole transport layer on the hole injection layer; evaporating an electron injection layer on the cathode layer; evaporating an electron transport layer on the electron injection layer; evaporating an emitting layer on the second insulator; and disposing a reference voltage layer on a side of the emitting layer.

[0015] In the organic light-emitting diode panel according to the preferred embodiment of the present invention, the pixel further includes a low impedance conductor layer, disposed on the emitting layer. By the current shunt, the OLED pixel breakdown is eliminated. In the other embodiment, the doping process is performed to the emitting layer, and the dopant may be donor or acceptor. Thus, the current flowing through the emitting layer is prevented from being excessively inclined toward the bottom of the emitting layer such that the OLED pixel breakdown is eliminated.

[0016] The present invention further provides a manufacturing method for organic light-emitting diode panel. Compared with the abovementioned method, the difference is that the reference voltage layer is disposed between the first cavity and the second cavity after the anode layer and the cathode layer are exposed respectively by the first cavity and the second cavity. In this preferred embodiment, it further includes disposing a low impedance organic layer, a transparent conductor layer or a thin metal layer on the emitting layer.

[0017] In the organic light-emitting diode panel according to the preferred embodiment of the present invention, the pixel further includes a low impedance conductor layer, disposed on the emitting layer. By the current shunt, the OLED pixel breakdown is avoided. In the other embodiment, the doping process is performed to implant a dopant in the emitting layer, and the dopant may be donor or acceptor. Thus, the carrier concentration of the upper side of the emitting layer is greater than the carrier concentration of lower side of the emitting layer. And, the current flowing through the emitting layer is prevented from being excessively inclined toward the lower side of the emitting layer, and then the OLED pixel breakdown is eliminated.

[0018] The spirit of the present invention is to change and improve the structure of OLED. The traditional stack manufacturing process is changed to an in-plane process, and the

aperture ratio is increased. Furthermore, a reference voltage layer is further added on the emitting layer such that the pixel can be operated as 3-terminal device. As such, if the OLED pixel in the present invention is able to function as an active matrix OLED panel, at least one TFT can be removed in each pixel as compared to the traditional OLED pixel design. Thus, the process and the circuit complexity can be greatly reduced and the manufacturing cost can be also reduced.

[0019] The present invention will become more fully understood from the detailed description given hereinbelow and the accompanying drawings which are given by way of illustration only, and thus are not limitative of the present invention.

BRIEF DESCRIPTION OF THE DRAWINGS

[0020] FIG. 1 illustrates a diagram depicting a current OLED device.

[0021] FIG. 2 illustrates a schematic depicting a white OLED device structure.

[0022] FIG. 3 illustrates a structure diagram depicting a pixel of the OLED panel according to a preferred embodiment of the present invention.

[0023] FIG. 4 illustrates a structure diagram depicting a pixel of the OLED panel according to a preferred embodiment of the present invention.

[0024] FIG. 5 illustrates a drawing depicting the luminance of the pixel of the OLED panel in respect to the reference voltage when the voltage between the anode and cathode is constant according to a preferred embodiment of the present invention.

[0025] FIG. 6 illustrates a structure diagram depicting a pixel of the OLED panel according to a preferred embodiment of the present invention.

[0026] FIG. 7 illustrates an equivalent circuit diagram depicting a pixel of the OLED panel according to a preferred embodiment of the present invention.

[0027] FIG. 8A illustrates a structure diagram depicting a white light pixel of the OLED panel according to a preferred embodiment of the present invention.

[0028] FIG. 8B illustrates a structure diagram depicting a white light pixel of the OLED panel according to a preferred embodiment of the present invention.

[0029] FIG. 8C illustrates a structure diagram depicting a white light pixel of the OLED panel according to a preferred embodiment of the present invention.

[0030] FIG. 9A illustrates a structure diagram depicting a white light pixel of the OLED panel according to a preferred embodiment of the present invention.

[0031] FIG. 9B illustrates a structure diagram depicting a white light pixel of the OLED panel according to a preferred embodiment of the present invention.

[0032] FIG. 9C illustrates a structure diagram depicting a white light pixel of the OLED panel according to a preferred embodiment of the present invention.

[0033] FIG. 10A illustrates a structure diagram depicting a white light pixel of the OLED panel according to a preferred embodiment of the present invention.

[0034] FIG. 10B illustrates a structure diagram depicting a white light pixel of the OLED panel according to a preferred embodiment of the present invention.

[0035] FIG. 10C illustrates a structure diagram depicting a white light pixel of the OLED panel according to a preferred embodiment of the present invention.

[0068] FIG. 17A illustrates a diagram depicting the step S1701 in the manufacturing method for organic light-emitting diode panel according to a preferred embodiment of the present invention.

[0069] FIG. 17B illustrates a diagram depicting the step S1702 in the manufacturing method for organic light-emitting diode panel according to a preferred embodiment of the present invention.

[0070] FIG. 17C illustrates a diagram depicting the step S1703 in the manufacturing method for organic light-emitting diode panel according to a preferred embodiment of the present invention.

[0071] FIG. 18 illustrates a flowchart depicting the manufacturing method for organic light-emitting diode panel in FIG. 9B according to a preferred embodiment of the present invention.

[0072] FIG. 18A illustrates a diagram depicting the step S1801 in the manufacturing method for organic light-emitting diode panel according to a preferred embodiment of the present invention.

[0073] FIG. 18B illustrates a diagram depicting the step S1802 in the manufacturing method for organic light-emitting diode panel according to a preferred embodiment of the present invention.

[0074] FIG. 18C illustrates a diagram depicting the step S1803 in the manufacturing method for organic light-emitting diode panel according to a preferred embodiment of the present invention.

[0075] FIG. 19 illustrates a flowchart depicting the manufacturing method for organic light-emitting diode panel in FIG. 9C according to a preferred embodiment of the present invention.

[0076] FIG. 19A illustrates a diagram depicting the step S1901 in the manufacturing method for organic light-emitting diode panel according to a preferred embodiment of the present invention.

[0077] FIG. 20 illustrates a flowchart depicting the manufacturing method for organic light-emitting diode panel in FIG. 10A according to a preferred embodiment of the present invention.

[0078] FIG. 20A illustrates a diagram depicting the step S2001 in the manufacturing method for organic light-emitting diode panel according to a preferred embodiment of the present invention.

[0079] FIG. 21 illustrates a flowchart depicting the manufacturing method for organic light-emitting diode panel in FIG. 10B according to a preferred embodiment of the present invention.

[0080] FIG. 21A illustrates a diagram depicting the step S2101 in the manufacturing method for organic light-emitting diode panel according to a preferred embodiment of the present invention.

[0081] FIG. 22 illustrates a flowchart depicting the manufacturing method for organic light-emitting diode panel in FIG. 10C according to a preferred embodiment of the present invention.

[0082] FIG. 22A illustrates a diagram depicting the step S2201 in the manufacturing method for organic light-emitting diode panel according to a preferred embodiment of the present invention.

[0083] FIG. 23 illustrates a flowchart depicting the manufacturing method for organic light-emitting diode panel in FIG. 11 according to a preferred embodiment of the present invention.

[0084] FIG. 23A illustrates a diagram depicting the step S2301 in the manufacturing method for organic light-emitting diode panel according to a preferred embodiment of the present invention.

[0085] FIG. 24 illustrates a structure diagram depicting a pixel of the OLED panel according to a preferred embodiment of the present invention.

[0086] FIG. 25 illustrates a structure diagram depicting the emitting layer 2408 of the pixel of the OLED panel according to a preferred embodiment of the present invention.

[0087] FIG. 26 illustrates a structure diagram depicting a pixel of the OLED panel according to a preferred embodiment of the present invention.

[0088] FIG. 27 illustrates a flowchart depicting the manufacturing method for organic light-emitting diode panel in FIG. 24 according to a preferred embodiment of the present invention.

[0089] FIG. 27A illustrates a diagram depicting the step S2704 in the manufacturing method for organic light-emitting diode panel according to a preferred embodiment of the present invention.

[0090] FIG. 27B illustrates a diagram depicting the step S2705 in the manufacturing method for organic light-emitting diode panel according to a preferred embodiment of the present invention.

[0091] FIG. 27C illustrates a diagram depicting the step S2706 in the manufacturing method for organic light-emitting diode panel according to a preferred embodiment of the present invention.

[0092] FIG. 27D illustrates a diagram depicting the step S2707 in the manufacturing method for organic light-emitting diode panel according to a preferred embodiment of the present invention.

[0093] FIG. 28 illustrates a simplified flowchart depicting the manufacturing method for organic light-emitting diode panel according to a preferred embodiment of the present invention.

[0094] FIG. 29 illustrates a simplified flowchart depicting the manufacturing method for organic light-emitting diode panel according to a preferred embodiment of the present invention.

DETAILED DESCRIPTION OF THE INVENTION

[0095] In the embodiments and claims, spatially relative terms, such as “underlying,” “below,” “lower,” “overlying,” “upper” and the like, may be used herein for ease of description to describe one element or feature’s relationship to another element(s) or feature(s) as illustrated in the figures. Those skilled in the art may understand that the spatially relative terms are intended to encompass different orientations of the apparatus in use or operation in addition to the orientation depicted in the figures. For example, if an apparatus in the drawing is turned over, elements or features described as “below” or “beneath” other elements or features would then be oriented “above” the other elements. The terms “below” or “beneath” can, therefore, encompass both an orientation of above and below. If the apparatus may be otherwise oriented (rotated 90 degrees or at other orientations), then the spatially relative descriptors used herein may likewise be interpreted accordingly.

[0096] FIG. 3 illustrates a structure diagram depicting a pixel of the OLED panel according to a preferred embodiment of the present invention. Referring to FIG. 3, the pixel

structure is non-stacked structure. The pixel includes an anode layer 300, a first insulator 301, a second insulator 302, a hole injection layer (HIL) 303, a hole transport layer (HTL) 304, a cathode layer 305, an electron injection layer (EIL) 306, an electron transport layer (ETL) 307 and an emitting layer 308. The anode layer 300 is disposed on the transparent substrate 30. The first insulator 301 is disposed on the anode layer 300. The cathode layer 305 is disposed on the first insulator 301. The second insulator 302 is disposed on the first insulator 301 and the cathode layer 305. The first insulator 301 and the second insulator 302 have a first cavity 309 and a second cavity 310. Further, the HIL 303 and HTL 304 are disposed in the first cavity 309. In the second cavity 310, the cathode layer 305, the EIL 306 and the ETL 307 is disposed from the bottom to top of the second cavity 310. In addition, the emitting layer 308 is disposed on the second insulator 302, the first cavity 309 and the second cavity 310.

[0097] According to the embodiment of the present invention, the emitting layer is disposed on a plane to achieve top emission. However, when the pixel is driven, the current would flow through the emitting layer 308 by a shortest path, as indicated by the reference numeral 311. So, the current would be accumulated at the lower side of the emitting layer 308. Under long-term operation, the material at the bottom of the emitting layer 308 would break down, and it also causes damage to the pixel.

[0098] FIG. 4 illustrates a structure diagram depicting a pixel of the OLED panel according to a preferred embodiment of the present invention. Referring to FIG. 4, to avoid the breakdown of the material at the bottom of the emitting layer 308, in this embodiment, a reference voltage layer 400 is disposed on the emitting layer 308. The reference voltage layer 400 is served as a reference electrode. To control the pixel, a reference voltage V_{ref} is additionally applied to the reference voltage layer 400, and the reference voltage V_{ref} would induce more minority carriers generated from the upper side of the emitting layer 308. Thus, the electrons in the emitting layer 308 are more easily combined with the holes to produce photons. The lower driving voltage between the anode and the cathode is required to make the pixel emit light. And, the luminous efficiency of the pixel would be increased.

[0099] Similarly, a reference voltage is additionally applied to the reference voltage layer 400, the opposite polarity of the charge carrier would be attracted away from the bottom of the emitting layer 308 by the reference voltage V_{ref} , and moves in the direction of the reference voltage layer 400, as indicated by the current path 401 illustrated in FIG. 4. Thus, the breakdown at the bottom of the emitting layer 308 would be eliminated.

[0100] FIG. 5 illustrates a drawing depicting the luminance of the pixel of the OLED panel in respect to the reference voltage when the voltage between the anode and cathode is constant according to a preferred embodiment of the present invention. Referring to FIG. 5, the voltage between the anode and the cathode is about 23V, and the shortest distance between the HTL and ETL is 18.41 μm . That is the reason why the driving voltage is so high. In this embodiment, the reference voltage V_{ref} is from 0 to -19V, and the luminance is changed from 40 to 55 nits. In this embodiment, because there is no insulation between the reference voltage layer 400 and the emitting layer 308, a partial current leakage from the reference voltage layer 400 may occur.

[0101] FIG. 6 illustrates a structure diagram depicting a pixel of the OLED panel according to a preferred embodiment of the present invention. Referring to FIG. 4 and FIG. 6, an insulator 601 is disposed between the reference voltage layer 400 and the emitting layer 308. The insulator 601 is used to block the current leakage from the emitting layer 308 to the reference voltage layer 400. Thus, the luminance control range would become greater. In one embodiment, the reference voltage layer 400 may be made of transparent conductor material.

[0102] FIG. 7 illustrates an equivalent circuit diagram depicting a pixel of the OLED panel according to a preferred embodiment of the present invention. Referring to FIG. 7, the equivalent circuit of the OLED pixel includes a TFT 701, a capacitor 703 and the OLED pixel 702. In this embodiment, the OLED pixel 702 includes an anode terminal 71, a cathode terminal 72 and a reference voltage terminal 73.

[0103] According to the abovementioned embodiment of the present invention, to apply a reference voltage V_{ref} to the reference voltage layer 400 can increase the minority carrier injection. On the contrary, to change the polarity of the reference voltage V_{ref} would reduce the minority carrier injection and the efficiency of photons production by recombination of electrons and holes. The brightness of the pixel is thus reduced and even the pixel may be unable to emit light. Therefore, by adjusting the polarity and/or the magnitude of the reference voltage V_{ref} , the reference voltage layer can be used to serve as a switch of the OLED pixel 702 or the means for adjusting the luminance of the OLED pixel 702. Based on this, each pixel only requires one TFT 701 as compared with at least two TFTs that the conventional OLED pixel requires. Thus, the present invention can achieve the same display effect with lesser components such as TFTs. In addition, the anode layer 300 and the reference voltage layer 400 may be implemented by ITO (Indium Tin Oxide), FTO (F_2SnO_2), AZO ($\text{ZnO}:\text{Al}$) and so on. The present invention is not limited thereto. In one embodiment, the anode layer 300 can also be made of a non-transparent conductor material.

[0104] FIG. 8A illustrates a structure depicting a white light pixel of the OLED panel according to a preferred embodiment of the present invention. Referring to FIG. 8, the white light OLED is formed by stacking. The white light OLED includes an anode layer 800, an HIL 801, an HTL 802, an ETL 803, an EIL 804, a cathode layer 805 and emitting layers capable of emitting at least two colors. In one embodiment, for example, three emitting layers 806-1, 806-2 and 806-3, which respectively are the red emitting material, the green emitting material and the blue emitting material, are adopted. When the current flows through the cathode layer from the anode layer, the current would pass through three emitting layers 806-1, 806-2 and 806-3. By mixing the red, green and blue lights, the white light is obtained. Moreover, when the red, green and blue materials are driven by a constant current, their luminous efficiencies are different. In this embodiment, the thickness of the three emitting layers 806-1, 806-2 and 806-3 are modified to change the mixing light by the red, green and blue lights, such that the color temperature of the white light can be adjusted.

[0105] Similarly, FIG. 8B illustrates a structure diagram depicting a white light pixel of the OLED panel according to a preferred embodiment of the present invention. Referring to FIG. 8A and FIG. 8B, the difference between two

figures is that the three emitting layers **806-1**, **806-2** and **806-3** are replaced by one emitting layer **807**. However, the emitting layer **807** adopts the material mixed by the red emitting material, the green emitting material and blue emitting material. Thus, when the current flows through the emitting layer **807**, the white light is emitted by mixing the red, green and blue lights. Furthermore, the color temperature can be also modified by changing the proportion of the red emitting material, the green emitting material and blue emitting material to modify or adjust the mixing light of the red, green and blue lights. In another embodiment, the emitting layer **807** can also adopt two different color emitting materials, such as the yellow and blue emitting materials, to emit white light. Similarly, the color temperature can be also adjusted by changing the proportion of two materials.

[0106] FIG. 8C illustrates a structure diagram depicting a white light pixel of the OLED panel according to a preferred embodiment of the present invention. Referring to FIG. 8A and FIG. 8C, the difference between two figures is that the three emitting layers **806-1**, **806-2**, **806-3** become a stacked structure. In FIG. 8C, the three emitting layers **806-1**, **806-2**, **806-3** are disposed on different positions of the same layer. When the current flows through the emitting layers **806-1**, **806-2**, **806-3**, the white light is emitted by mixing the red, green and blue lights. Besides, the color temperature can be also modified by changing the proportion of the sizes of the red emitting material, the green emitting material and blue emitting material to modify the mixing light of the red, green and blue lights. Understandably, the two emitting layers can be adopted in this embodiment instead of three emitting layer, such as the yellow and blue emitting layers, to emit the white light

[0107] FIG. 9A illustrates a structure diagram depicting a white light pixel of the OLED panel according to a preferred embodiment of the present invention. Referring to FIG. 9A, the pixel includes an anode layer **900**, a first insulator **901**, a second insulator **902**, an HIL **903**, an HTL **904**, a cathode layer **905**, an EIL **306**, an ETL **307** and three emitting layers **908-1**, **908-2** and **908-3**. Compared with the embodiment in FIG. 3, the three emitting layers **908-1**, **908-2** and **908-3** respectively are the red emitting material, the green emitting material and the blue emitting material. When the current flows from the anode to cathode, the current would pass through the three emitting layers **908-1**, **908-2** and **908-3**. The white light is emitted by mixing the red, green and blue lights. Besides, when the red, green and blue materials are driven by a constant current, the luminous efficiencies are different. In this embodiment, the occupied areas of the three emitting layers **908-1**, **908-2**, and **908-3** can be modified to change the mixing light by the red, green and blue lights, such that the color temperature of the white light can be adjusted.

[0108] FIG. 9B illustrates a structure diagram depicting a white light pixel of the OLED panel according to a preferred embodiment of the present invention. Referring to FIG. 9B, similarly, the three emitting layers **908-4**, **908-5** and **908-6** are adopted in this embodiment. However, the three emitting layers **908-4**, **908-5** and **908-6** are disposed in stack. FIG. 9C illustrates a structure diagram depicting a white light pixel of the OLED panel according to a preferred embodiment of the present invention. Referring to FIG. 9C, similarly, the three emitting layers can be integrated into one emitting layer **909** as FIG. 8B. Therefore, it is only necessary to adjust the

proportion of those emitting materials. The present invention is not limited thereto. Furthermore, although the embodiment adopts three emitting layers as an example, two emitting layers can be also implemented to emit white light, such as the blue emitting material and yellow material as described above. Thus, the present invention is not limited thereto.

[0109] Similarly, FIGS. 9A, 9B and 9C disclose a top emission by horizontally disposing the emitting layer in a plane. However, when the pixel is illuminated, the current would flow through a shortest path (the lowest resistance path), as labeled by reference numeral **911**. As such, the current is accumulated at the bottom of the emitting layers **908-1**, **908-2** and **908-3**. Under long-term operation, the bottom of the emitting layer would break down, and it also causes damage to the pixel

[0110] FIG. 10A illustrates a structure diagram depicting a white light pixel of the OLED panel according to a preferred embodiment of the present invention. Referring to FIG. 9A and FIG. 10A, in order to avoid the breakdown of the bottom of the emitting layer, in this embodiment, a reference voltage layer **1000** is disposed on the emitting layers **908-1**, **908-2**, and **908-3**. The reference voltage layer **1000** is used to serve as a reference voltage electrode. To control the pixel, a reference voltage V_{ref} is additionally applied to the reference voltage layer **1000**, and the reference voltage V_{ref} would induce more minority carriers generating from the upper side of the emitting layers **908-1**, **908-2**, and **908-3**. Thus, the electrons in the emitting layers **908-1**, **908-2** and **908-3** are more easily combined with the holes to produce photons. The lower driving voltage between the anode and the cathode can be used to illuminate the pixel. And, the luminous efficiency of the pixel would be increased. Since the operation in FIG. 10A is similar to the operation in FIG. 4, the detail description is omitted.

[0111] FIG. 10B illustrates a structure diagram depicting a white light pixel of the OLED panel according to a preferred embodiment of the present invention. Referring to FIG. 9B and FIG. 10B, the current path can be changed by applying the reference voltage V_{ref} to the reference voltage layer **1000**. The operation in FIG. 10B is similar to the operation in FIG. 10A, so the detail description is omitted. FIG. 10C illustrates a structure diagram depicting a white light pixel of the OLED panel according to a preferred embodiment of the present invention. Referring to FIG. 9C and FIG. 10C, the current path can be changed by applying the reference voltage V_{ref} to the reference voltage layer **1000**. The operation in FIG. 10C is similar to the operation in FIG. 10A, so the detailed description is omitted.

[0112] FIG. 11 illustrates a structure diagram depicting a white light pixel of the OLED panel according to a preferred embodiment of the present invention. Referring to FIG. 10A, FIG. 11 and FIG. 6, similarly, in this embodiment, an insulator **1101** is disposed between the reference voltage layer **1000** and the emitting layers **908-1**, **908-2**, **908-3**. The insulator **1101** is used for blocking the current leakage from the emitting layers **908-1**, **908-2** and **908-3** to the reference voltage layer **1000**. Thus, the luminance control range would be greater. The same insulator **1101** can be also adopted in FIG. 10B and FIG. 10C. The detailed description is omitted herein for simplicity.

[0113] FIG. 12 illustrates a flowchart depicting a manufacturing method for organic light-emitting diode panel in FIG. 4 according to a preferred embodiment of the present

invention. Referring to FIG. 12, the manufacturing method for organic light-emitting diode panel includes the steps as follow.

[0114] In steps S1200, the method starts.

[0115] In step S1201, the anode layer 1201 is disposed on a transparent substrate, such as a glass substrate. As shown in FIG. 12A, it illustrates a diagram depicting the step S1201 in the manufacturing method for organic light-emitting diode panel according to a preferred embodiment of the present invention. In step S1202, the first insulator 1202 is disposed on the anode layer 1201. FIG. 12B illustrates a diagram depicting the step S1202 in the manufacturing method for organic light-emitting diode panel according to a preferred embodiment of the present invention. In one embodiment, the transparent substrate can be a flexible one made of plastic material.

[0116] In step S1203, the cathode layer 1203 is disposed on the first insulator 1202. FIG. 12C illustrates a diagram depicting the step S1203 in the manufacturing method for organic light-emitting diode panel according to a preferred embodiment of the present invention. In step S1204, the second insulator 1204 is disposed on the first insulator 1202. FIG. 12D illustrates a diagram depicting the step S1204 in the manufacturing method for organic light-emitting diode panel according to a preferred embodiment of the present invention.

[0117] In step S1205, the second insulator 1204 and the first insulator 1202 are etched to form a first cavity 1205 and a second cavity 1206. FIG. 12E illustrates a diagram depicting the step S1205 in the manufacturing method for organic light-emitting diode panel according to a preferred embodiment of the present invention. In this illustration, the first cavity 1205 and the second cavity 1206 is form by the etching process. In addition, the bottom of the second cavity 1206 exposes the cathode layer 1203. The cathode layer 1203 is generally made of a metal material, which is not able to be etched during this etching process.

[0118] In step S1206, the HIL 1207 is evaporated in the first cavity 1205. FIG. 12F illustrates a diagram depicting the step S1206 in the manufacturing method for organic light-emitting diode panel according to a preferred embodiment of the present invention. Referring to FIG. 12F, through the metal mask MSK1, the material of HIL is accurately evaporated into the first cavity 1205. In step S1207, the HTL 1208 is evaporated on the HIL 1207. FIG. 12G illustrates a diagram depicting the step S1207 in the manufacturing method for organic light-emitting diode panel according to a preferred embodiment of the present invention. Referring to FIG. 12G, through the metal mask MSK1, the material of HTL is accurately evaporated into the first cavity 1205 and stacked on the HIL 1207.

[0119] In step S1208, the EIL 1209 is evaporated on the cathode layer 1203. FIG. 12H illustrates a diagram depicting the step S1208 in the manufacturing method for organic light-emitting diode panel according to a preferred embodiment of the present invention. In FIG. 12H, the opening area of the metal mask MSK1 is shifted to the upper side of the second cavity 1206. After that, evaporating EIL is performed, such that the material of the EIL is stacked on the cathode layer 1203.

[0120] In step S1209, the ETL 1210 is evaporated on the EIL 1209. FIG. 12I illustrates a diagram depicting the step S1209 in the manufacturing method for organic light-emitting diode panel according to a preferred embodiment of the

present invention. Referring to FIG. 12I, evaporating the ETL 1210 is performed such that the material of the ETL 1210 is stacked on the EIL 1209. Generally, the ETL 1210 is very thin. This diagram is only a schematic illustration, not a real proportion.

[0121] In step S1210, the emitting layer 1211 is evaporated on the second insulator 1204, wherein the emitting layer 1211 covers the first cavity 1205 and the second cavity 1206. FIG. 12J illustrates a diagram depicting the step S1210 in the manufacturing method for organic light-emitting diode panel according to a preferred embodiment of the present invention. Referring to FIG. 12J, the emitting layer 1211 also adopts the evaporating process. Thus, another metal mask MSK2 is required. Generally, the emitting layer 1211 is red, green or blue organic emitting materials.

[0122] In step S1211, the reference voltage layer 1212 is disposed on the emitting layer 1211. FIG. 12K illustrates a diagram depicting the step S1211 in the manufacturing method for organic light-emitting diode panel according to a preferred embodiment of the present invention. Referring to FIG. 12K, as such, the three-terminal OLED pixel, to which a reference voltage can be applied, as shown in FIG. 4 is completed.

[0123] FIG. 13 illustrates a flowchart depicting the manufacturing method for organic light-emitting diode panel in FIG. 6 according to a preferred embodiment of the present invention. Referring to FIG. 12 and FIG. 13, between the step S1210 and the step S1211, the method further includes the step as follow.

[0124] In step S1301, a third insulator 1301 is disposed on the emitting layer 1211. As shown in FIG. 13A, FIG. 13A illustrates a diagram depicting the step S1301 in the manufacturing method for organic light-emitting diode panel according to a preferred embodiment of the present invention. Referring to FIG. 13, the insulator 1301 is a thin isolation film. Next, through the step S1211, the OLED pixel shown on FIG. 6 can be obtained.

[0125] FIG. 14 illustrates a flowchart depicting the manufacturing method for organic light-emitting diode panel in FIG. 8A according to a preferred embodiment of the present invention. Referring to FIG. 14, the manufacturing method for white light pixel of OLED panel includes the steps as follow.

[0126] In step S1400, the method starts.

[0127] In step S1401, the anode layer 1401 is disposed on a transparent substrate, such as a glass substrate. FIG. 14A illustrates a diagram depicting the step S1401 in the manufacturing method for organic light-emitting diode panel according to a preferred embodiment of the present invention. The anode layer 1401 may adopt a transparent conductor material or a non-transparent conductor material.

[0128] In step S1402, through the metal mask MSK141, the HIL 1402 is evaporated. FIG. 14B illustrates a diagram depicting the step S1402 in the manufacturing method for organic light-emitting diode panel according to a preferred embodiment of the present invention. In step S1403, the HTL 1403 is evaporated on the HIL 1402 through the metal mask MSK141. FIG. 14C illustrates a diagram depicting the step S1403 in the manufacturing method for organic light-emitting diode panel according to a preferred embodiment of the present invention.

[0129] In step S1404, the first emitting layer 1404 is evaporated on the HTL 1403 through the metal mask MSK141. FIG. 14D illustrates a diagram depicting the step

S1404 in the manufacturing method for organic light-emitting diode panel according to a preferred embodiment of the present invention. In step **S1405**, the second emitting layer **1405** is evaporated on the first emitting layer **1404** through the metal mask **MSK141**. FIG. **14E** illustrates a diagram depicting the step **S1405** in the manufacturing method for organic light-emitting diode panel according to a preferred embodiment of the present invention.

[**0130**] In step **S1406**, the third emitting layer **1406** is evaporated on the second emitting layer **1405** through the metal mask **MSK141**. FIG. **14F** illustrates a diagram depicting the step **S1406** in the manufacturing method for organic light-emitting diode panel according to a preferred embodiment of the present invention. In step **S1407**, the ETL **1407** is evaporated on the third emitting layer **1406** through the metal mask **MSK141**. FIG. **14G** illustrates a diagram depicting the step **S1407** in the manufacturing method for organic light-emitting diode panel according to a preferred embodiment of the present invention.

[**0131**] In step **S1408**, the EIL **1408** is evaporated on the ETL **1407** through the metal mask **MSK141**. FIG. **14H** illustrates a diagram depicting the step **S1408** in the manufacturing method for organic light-emitting diode panel according to a preferred embodiment of the present invention. In step **S1409**, the cathode layer **1409** is disposed on the EIL **1408**. FIG. **14I** illustrates a diagram depicting the step **S1409** in the manufacturing method for organic light-emitting diode panel according to a preferred embodiment of the present invention. Generally, the cathode layer **1409** may be a thin metal layer.

[**0132**] FIG. **15** illustrates a flowchart depicting the manufacturing method for organic light-emitting diode panel in FIG. **8B** according to a preferred embodiment of the present invention. Referring to FIG. **15**, in this method, the steps **S1404** to **S1406** is canceled, and the method between the step **S1403** and the step **S1407** includes the step as follow.

[**0133**] In step **S1501**, the hybrid emitting layer **1501**. FIG. **15A** illustrates a diagram depicting the step **S1501** in the manufacturing method for organic light-emitting diode panel according to a preferred embodiment of the present invention. Referring to FIG. **15A**, in this embodiment, the hybrid emitting material of the hybrid emitting layer **1501** may be the material by mixing red, green and blue emitting material. Moreover, the color temperature can be also modified by the ways described above, the detailed description is thus omitted.

[**0134**] FIG. **16** illustrates a flowchart depicting the manufacturing method for organic light-emitting diode panel in FIG. **8C** according to a preferred embodiment of the present invention. Referring to FIG. **16**, in this method, the steps **S1404** to **S1406** is canceled, and the method between the step **S1403** and the step **S1407** includes the steps as follows.

[**0135**] In step **S1601**, the first emitting layer **1601** is evaporated through the second metal mask **MSK161**. FIG. **16A** illustrates a diagram depicting the step **S1601** in the manufacturing method for organic light-emitting diode panel according to a preferred embodiment of the present invention. In step **S1602**, the second metal mask **MSK161** is shifted, and the second emitting layer **1602** is evaporated. FIG. **16B** illustrates a diagram depicting the step **S1602** in the manufacturing method for organic light-emitting diode panel according to a preferred embodiment of the present invention.

[**0136**] In step **S1603**, the second metal mask **MSK161** is further shifted, and the third emitting layer **1603** is evaporated. FIG. **16C** illustrates a diagram depicting the step **S1603** in the manufacturing method for organic light-emitting diode panel according to a preferred embodiment of the present invention. After the step **S1603**, the steps of evaporating the ETL, EIL and disposing the cathode layer are the same as above. The detailed description is herein omitted.

[**0137**] FIG. **17** illustrates a flowchart depicting the manufacturing method for organic light-emitting diode panel in FIG. **9A** according to a preferred embodiment of the present invention. Referring to FIG. **12** and FIG. **17**, since the preceding steps of the manufacturing method for organic light-emitting diode panel in FIG. **9A** are the same as the steps **S1201** to **S1209** in FIG. **12**, the preceding steps can refer to the steps **S1201** to **S1209** and the corresponding FIG. **12A** to FIG. **12I**. Moreover, subsequent to the step **S1209**, the method further includes the steps as follow.

[**0138**] In step **S1701**, the first emitting layer **1701** is evaporated through the second metal mask **MSK171**. As shown in FIG. **17A**, FIG. **17A** illustrates a diagram depicting the step **S1701** in the manufacturing method for organic light-emitting diode panel according to a preferred embodiment of the present invention. Referring to FIG. **17A**, the schematic diagram is that the first emitting layer **1701** is evaporated at FIG. **12I** of the step **S1209** after FIG. **12I** of the step **S1209** turning 180 degree.

[**0139**] In step **S1702**, the second metal mask **MSK171** is shifted and the second emitting layer **1702** is evaporated. As shown in FIG. **17B**, FIG. **17B** illustrates a diagram depicting the step **S1702** in the manufacturing method for organic light-emitting diode panel according to a preferred embodiment of the present invention.

[**0140**] In step **S1703**, the second metal mask **MSK171** is further shifted and the third emitting layer **1702** is evaporated. As shown in FIG. **17C**, FIG. **17C** illustrates a diagram depicting the step **S1703** in the manufacturing method for organic light-emitting diode panel according to a preferred embodiment of the present invention. Generally, the first emitting layer **1701**, the second emitting layer **1702** and the third emitting layer **1703** are respectively red, green and blue emitting materials.

[**0141**] FIG. **18** illustrates a flowchart depicting the manufacturing method for organic light-emitting diode panel in FIG. **9B** according to a preferred embodiment of the present invention. Referring to FIG. **12** and FIG. **18**, some steps of the manufacturing method for organic light-emitting diode panel in FIG. **9B** are the similar to the steps **S1201** to **S1209** in FIG. **12**, the similar steps in FIG. **12** can refer to the steps **S1201** to **S1209** and the corresponding FIGS. **12A-12I**. Subsequent to the step **S1209**, the method further includes the steps as follow.

[**0142**] In step **S1801**, the first emitting layer **1801** is evaporated. FIG. **18A** illustrates a diagram depicting the step **S1801** in the manufacturing method for organic light-emitting diode panel according to a preferred embodiment of the present invention. Referring to FIG. **18A**, since the emitting layer **1801** is formed by the evaporating process, another metal mask **MSK181** is required.

[**0143**] In step **S1802**, the second emitting layer **1802** is evaporated. FIG. **18B** illustrates a diagram depicting the step **S1802** in the manufacturing method for organic light-emitting diode panel according to a preferred embodiment of the present invention. In step **S1803**, the third emitting layer

1803 is evaporated. FIG. **18C** illustrates a diagram depicting the step **S1803** in the manufacturing method for organic light-emitting diode panel according to a preferred embodiment of the present invention. Generally, the first emitting layer **1801**, the second emitting layer **1802** and the third emitting layer **1803** may be respectively red, green and blue emitting materials.

[0144] FIG. **19** illustrates a flowchart depicting the manufacturing method for organic light-emitting diode panel in FIG. **9C** according to a preferred embodiment of the present invention. Referring to FIG. **12** and FIG. **19**, some steps of the manufacturing method for organic light-emitting diode panel in FIG. **9C** are the similar to the steps **S1201** to **S1209** in FIG. **12**, the similar steps in FIG. **12** can refer to the steps **S1201** to **S1209** and the corresponding FIGS. **12A-12I**. Moreover, subsequent to the step **S1209**, the method further includes the step as follows.

[0145] In step **S1901**, a hybrid emitting material **1901** is evaporated. As shown in FIG. **19A**, FIG. **19A** illustrates a diagram depicting the step **S1901** in the manufacturing method for organic light-emitting diode panel according to a preferred embodiment of the present invention. Referring to FIG. **19A**, the emitting layer **1801** is formed by the evaporating process, and another metal mask **MSK181** is required. Further, the hybrid emitting material of the hybrid emitting material **1901** is generally a material mixing by red, green and blue emitting materials.

[0146] FIG. **20** illustrates a flowchart depicting the manufacturing method for organic light-emitting diode panel in FIG. **10A** according to a preferred embodiment of the present invention. Referring to FIGS. **12**, **17** and **20**, some steps of the manufacturing method for organic light-emitting diode panel in FIG. **10A** are the similar to the steps **S1201** to **S1209** in FIG. **12** and the steps **S1701** to **S1703** in FIG. **17**, the similar steps in FIGS. **12** and **17** can refer to the steps **S1201** to **S1209** and the corresponding FIGS. **12A-12I** and the steps **S1701** to **S1703** and the corresponding FIG. **17A** to FIG. **17C**. Moreover, subsequent to the step **S1703**, the method further includes the step as follows.

[0147] In step **S2001**, a reference voltage layer **2001** is disposed. FIG. **20A** illustrates a diagram depicting the step **S2001** in the manufacturing method for organic light-emitting diode panel according to a preferred embodiment of the present invention. Referring to FIG. **20A**, in order to eliminate the breakdown occurring at the bottom of the emitting layers **1701**, **1702**, **1703**, in this embodiment, the reference voltage layer **2001** is additionally disposed on the upper layer of the emitting layers **1701**, **1702**, **1703**. The reference voltage layer **2001** is used to serve as the reference voltage electrode. Since the operation is described above, the detailed description is herein omitted.

[0148] FIG. **21** illustrates a flowchart depicting the manufacturing method for organic light-emitting diode panel in FIG. **10B** according to a preferred embodiment of the present invention. Referring to FIG. **12**, FIG. **18** and FIG. **21**, some steps of the manufacturing method for organic light-emitting diode panel in FIG. **10B** are the similar to the steps **S1201** to **S1209** in FIG. **12** and the steps **S1801** to **S1803** in FIG. **18**, the similar steps in FIGS. **12** and **18** can refer to the steps **S1201** to **S1209** and the corresponding FIGS. **12A-12I** and the steps **S1801** to **S1803** and the corresponding FIG. **18A** to FIG. **18C**. Moreover, subsequent to the step **S1803**, the method further includes the step as follows.

[0149] In step **S2101**, the reference voltage layer **2101** is disposed. As shown in FIG. **21A**, FIG. **21A** illustrates a diagram depicting the step **S2101** in the manufacturing method for organic light-emitting diode panel according to a preferred embodiment of the present invention. Referring to FIG. **21A**, since the operation is the same as the operation in FIG. **20A**, the redundant description is herein omitted.

[0150] FIG. **22** illustrates a flowchart depicting the manufacturing method for organic light-emitting diode panel in FIG. **10C** according to a preferred embodiment of the present invention. Referring to FIG. **12**, FIG. **19** and FIG. **22**, some steps of the manufacturing method for organic light-emitting diode panel in FIG. **10C** are the similar to the steps **S1201** to **S1209** in FIG. **12** and the step **S1901** in FIG. **19**, the similar steps in FIGS. **12** and **18** can refer to the steps **S1201** to **S1209** and the corresponding FIGS. **12A-12I** and the step **S1901** and the corresponding FIG. **19A**. Moreover, subsequent to the step **S1901**, the method further includes the step as follows.

[0151] In step **S2201**, the reference voltage layer **2201** is disposed. As shown in FIG. **22A**, FIG. **22A** illustrates a diagram depicting the step **S2201** in the manufacturing method for organic light-emitting diode panel according to a preferred embodiment of the present invention. Referring to FIG. **22A**, the operation in this embodiment is the same as the operation in FIG. **20A**, the redundant description is herein omitted.

[0152] FIG. **23** illustrates a flowchart depicting the manufacturing method for organic light-emitting diode panel in FIG. **11** according to a preferred embodiment of the present invention. Referring to FIG. **20** and FIG. **23**, since some steps of the manufacturing method for organic light-emitting diode panel in FIG. **11** are the similar as the steps **S1201** to **S1209** and the steps **S1701** to **S1703** in FIG. **20**, those steps can refer to the steps **S1201** to **S1209** and the corresponding FIGS. **12A-12I** and the steps **S1701** to **S1703** and the corresponding FIGS. **17A-17C**. Moreover, subsequent to the step **S1703**, the method further includes the step as follows.

[0153] In step **S2301**, the third insulator **2301** is disposed on the first emitting layer **1701** to the third emitting layer **1703**. As shown in FIG. **23A**, FIG. **23A** illustrates a diagram depicting the step **S2301** in the manufacturing method for organic light-emitting diode panel according to a preferred embodiment of the present invention. Referring to FIG. **23A**, the third insulator **2301** is a thin isolation film. Next, through the step **S2001** to form the reference voltage layer, the OLED pixel shown on FIG. **11** is obtained.

[0154] Similarly, the insulator can be disposed between the emitting layer and reference voltage layer in FIG. **10B** and FIG. **10C**, such that the white OLED pixel becomes three terminal OLED. Since the operation is described before, the duplicate description is herein omitted. It is noted that although the three emitting materials are mixed in the abovementioned embodiments, it may use two emitting materials such as yellow and cyan emitting materials to emit white light. Accordingly, the abovementioned embodiments are not intended to limit the present invention.

[0155] FIG. **24** illustrates a structure diagram depicting a pixel of the OLED panel according to a preferred embodiment of the present invention. Referring to FIG. **24**, the anode layer and the cathode layer are disposed by non-stacked structure. The pixel includes an anode layer **2400**, a first insulator **2401**, a second insulator **2402**, an IIL **2403**,

an HTL 2404, a cathode layer 2405, an EIL 2406, an ETL 2407, an emitting layer 2408, a third insulator 2421 and a reference voltage layer 2420.

[0156] According to the embodiment of the present invention, the emitting layer is horizontally disposed to achieve top emission. The reference voltage layer is disposed between the first cavity 2409 and the second cavity 2410 and serves as the reference voltage electrode. To control the pixel, a reference voltage is applied to the reference voltage layer 2420 to induce the emitting layer 2408 generating more minority carrier. Thus, the holes and electrons in the emitting layer 2408 are easily combined to produce photons. Therefore, the lower driving voltage between the anode and the cathode is required to make the pixel emit light. And, the luminous efficiency of the pixel is increased at the same time.

[0157] Since the reference voltage layer 2420 is disposed below the emitting layer 2408, the luminous efficiency would not be affected. Thus, more variety of material can be adopted as the reference voltage layer 2420, for example, it can be a transparent conductor layer or a non-transparent conductor layer. Furthermore, the present embodiment increases the process stability, the process yield, and reduces the cost, the damage possibility of the emitting layer 2408. Thereby, the reliability of the product is improved. The present embodiment may also solve the breakdown of the in-plane OLED.

[0158] In this embodiment, since the reference voltage layer 2420 is disposed under the emitting layer 2408. When the reference voltage V_{ref} is applied to the reference voltage layer 2420, the minority carrier injection would be increased to enhance the luminance. However, the current would pass the shortest path, and the current would tend to flow through the bottom side of the emitting layer. In the worst case, the breakdown 2422 would occur at the bottom side of the emitting layer 2408. In order to avoid the situation, several embodiments are provided in following paragraphs.

[0159] FIG. 25 illustrates a structure diagram depicting the emitting layer 2408 of the pixel of the OLED panel according to a preferred embodiment of the present invention. Referring to FIG. 25, in this embodiment, the emitting layer 2408 is additionally doped a donor (n-type) dopant or an acceptor (p-type) dopant 2501. During the process of the emitting layer 2408, the organic material with donor or acceptor 2501 is evaporated. Alternatively, an organic material with donor or acceptor is further re-evaporated on the emitting layer 2408. By controlling the distribution of the dopant concentration in the emitting layer during the doping process, the resistance value distribution of the emitting layer can be controlled. And, the subsequent current flow is controlled.

[0160] FIG. 26 illustrates a structure diagram depicting a pixel of the OLED panel according to a preferred embodiment of the present invention. Referring to FIG. 26, a low impedance material 2600 is evaporated on the emitting layer 2408. By the affection of the low impedance material 2600, the current is divided such that the current would not only flow through the shortest path. And, the breakdown of the OLED is eliminated.

[0161] Similarly, the pixel circuit in FIG. 7 can be adopted in this embodiment, and at least one TFT used by each pixel can be reduced to achieve the same display effect. In addition, the anode layer 2400 and the reference voltage

layer 2420 can also adopt the non-transparent conductor material. Therefore, more variety of material can be adopted in the present invention.

[0162] FIG. 27 illustrates a flowchart depicting the manufacturing method for organic light-emitting diode panel in FIG. 24 according to a preferred embodiment of the present invention. The similar steps can refer to FIG. 12 and FIGS. 12A-12K, and the detailed description is omitted. In this embodiment, only the different steps S2705-S2707 are described.

[0163] In step S2705, after finish the step S2704, as shown in FIG. 27A, the reference voltage layer 2705 is disposed on the second insulator 2704 as shown in FIG. 27B. In step S2706, the third insulator 2706 is disposed on the second insulator 2704, as shown in FIG. 27C.

[0164] In step S2707, the first insulator 2702, the second insulator 2704 and the third insulator 2706 are etched to generate a first cavity 2707 and a second cavity 2708 such that the anode layer 2701 and the cathode layer 2703 is exposed, as shown in FIG. 27D. In addition, the bottom of the second cavity 2708 is the cathode layer 2703, the material of the cathode layer 2703 may be the metal. Thus, the cathode layer 2703 would not be etched. It is noted that the reference voltage layer 2705 in this embodiment is disposed between the first cavity 2707 and the second cavity 2708. That is to say, the reference voltage layer 2705 can be disposed before the emitting layer to prevent the emitting layer from the damage caused by the high temperature process.

[0165] In the abovementioned embodiment, in order to effectively solve the breakdown of the 3-terminal OLED, two methods can be adopted. FIG. 28 illustrates a simplified flowchart depicting the manufacturing method for organic light-emitting diode panel according to a preferred embodiment of the present invention. As shown in FIG. 28, in addition to the abovementioned steps S2700 to S2712, the method further includes the step as follow.

[0166] In step S2801, a doping process is performed when the emitting layer is evaporated. The doping carrier may be an organic material with donor dopant or an organic material with acceptor dopant. Thus, the electrical conduction of the upper layer of the emitting layer would be increased, and the current would tend to flow through the upper layer. The present invention is not limited thereto. In a preferred embodiment, the step S2801 may be performed during the process of the emitting layer 2408 since the dopant can be evaporated with the emitting layer 2408. Also, the step S2801 may be performed after the process of the emitting layer 2408. Therefore, the present invention is not limited thereto.

[0167] The abovementioned embodiment adopts the doping process to control the carrier concentration distribution of the organic emitting layer such that the concentration of the upper layer is higher. Thus, the current is adjusted to incline toward the upper layer of the emitting layer. Referring to FIG. 29, subsequent to the step S2712, the method further includes the step as follow.

[0168] In step S2901, a low impedance conductor layer is disposed on the emitting layer. The low impedance conductor layer may be the low impedance organic material, a transparent conductor or a thin film metal. By reducing the impedance of the upper layer, the current tends to flow to the upper layer, thereby the breakdown of the 3-terminal OLED in the embodiment of the present invention is eliminated.

[0169] In summary, the spirit of the present invention is to change the structure of OLED. The original stack manufacturing process is changed to the planar process, and the aperture rate is increased. Furthermore, a reference voltage layer is further added on the emitting layer such that the pixel can be operated as a 3-terminal device. As such, if the OLED pixel in the present invention is able to function as an active matrix OLED panel, at least one TFT can be removed compared to the traditional OLED pixel design. Thus, the process and the circuit complexity can be greatly reduced and the manufacturing cost can be also reduced.

[0170] In a further embodiment, between the insulators, a reference voltage layer is embedded. By the reference voltage layer, the current path in the emitting layer is controlled so that the OLED pixel can be controlled as the three terminal devices. Since this reference voltage layer is buried inside the insulators, the light transmittance is increased, and more variety of material can be adopted. And, the material is not limited to the transparent material.

[0171] In addition, in the white OLED, the stack structure of the white light OLED in the prior art is changed to a parallel structure in the present invention. And, the metal mask shifting method is adopted for the manufacturing method in the embodiments of the present invention, and manufacturing process is simplified. And, compared with the conventional manufacture, the manufacturing steps in the embodiments are more streamlined.

[0172] While the present invention has been described by way of examples and in terms of preferred embodiments, it is to be understood that the present invention is not limited thereto. To the contrary, it is intended to cover various modifications. Therefore, the scope of the appended claims should be accorded the broadest interpretation so as to encompass all such modifications.

What is claimed is:

1. A organic light-emitting diode panel, comprising: at least a pixel, wherein the pixel comprises:
 - an anode layer, disposed on a substrate;
 - a first insulator, disposed on the anode layer;
 - a cathode layer, disposed on the first insulator;
 - a second insulator, disposed on the anode layer, having a first cavity and a second cavity, wherein a bottom of the second cavity exposes the cathode layer and a bottom of the first cavity exposes the anode layer;
 - a hole injection layer, disposed on the first cavity, and disposed on the anode layer;
 - a hole transport layer, disposed on the first cavity and disposed on the hole injection layer;
 - a electron injection layer, disposed on the second cavity and disposed on the cathode layer;
 - a electron transport layer, disposed on the second cavity and disposed on the electron injection layer;
 - an emitting layer, disposed on the second insulator; and
 - a reference voltage layer, disposed on a side of the emitting layer, wherein a three-terminal OLED is formed by the anode layer, the cathode layer and the reference voltage layer.
2. The organic light-emitting diode panel according to claim 1, wherein the pixel further comprises:
 - a third insulator, disposed between the reference voltage layer and the emitting layer.
3. The organic light-emitting diode panel according to claim 1, wherein the pixel further comprises:

- a thin film transistor, comprising a gate terminal, a first source/drain terminal and a second source/drain terminal, wherein the gate terminal of the thin film transistor is coupled to a scan line, the first source/drain terminal of the thin film transistor is coupled to a data line, the second source/drain terminal of the thin film transistor is coupled to the reference voltage layer; and

- a capacitor, comprising a first terminal and a second terminal, wherein the first terminal of the capacitor is coupled to the second source/drain terminal of the thin film transistor, and the second terminal of the capacitor is coupled to a common voltage.

4. The organic light-emitting diode panel according to claim 1, wherein a voltage of the reference voltage layer is used to control a current from the anode layer to the cathode layer through the emitting layer, and a current path in the emitting layer.

5. The organic light-emitting diode panel according to claim 1, wherein the emitting layer covers the first cavity and the second cavity, wherein the emitting layer further comprises:

- a first color emitting material;
- a second color emitting material, disposed by a side of the first color emitting material; and
- a third color emitting material, disposed by a side of the second color emitting material,

wherein the pixel emits the white light by mixing a first color light, a second color light and a third color light, which are respectively emitted from the first color emitting material, the second color emitting material and the third color emitting material.

6. The organic light-emitting diode panel according to claim 1, wherein the emitting layer covers the first cavity and the second cavity, wherein the emitting layer further comprises:

- a first color emitting material;
- a second color emitting material, disposed on the first color emitting material; and
- a third color emitting material, disposed on the second color emitting material,

wherein the pixel emits white light by mixing a first color light, a second color light and a third color light, which are respectively emitted from the first color emitting material, the second color emitting material and the third color emitting material.

7. The organic light-emitting diode panel according to claim 1, wherein the material of the emitting layer comprises at least two different color emitting materials.

8. The organic light-emitting diode panel according to claim 7, wherein the two different color emitting materials is horizontally disposed on a same layer, wherein the pixel emits the white light by mixing two color lights respectively emitted from the two different color emitting materials.

9. The organic light-emitting diode panel according to claim 7, wherein the two different color emitting materials is vertically stacked, wherein the pixel emits the white light by mixing two color lights respectively emitted from the two different color emitting materials.

10. The organic light-emitting diode panel according to claim 2, wherein the reference voltage layer is disposed under the emitting layer, wherein the third insulator covers the reference voltage layer when the reference voltage layer is disposed between the first cavity and the second cavity.

11. The organic light-emitting diode panel according to claim 10, wherein the pixel further comprises:

a low impedance conductor layer disposed on the emitting layer.

12. The organic light-emitting diode panel according to claim 10, wherein the emitting layer further comprises:

a dopant, for increasing the conduction of an upper layer of the emitting layer by doping process.

13. The organic light-emitting diode panel according to claim 1, wherein the reference voltage layer comprises Indium Tin Oxide.

14. A manufacturing method for organic light-emitting diode panel, comprising:

performing a sputtering process to form an anode layer on a substrate;

disposing a first insulator on the anode layer;

disposing a cathode layer on the first insulator;

disposing a second insulator on the first insulator;

etching the first insulator and the second insulator to form a first cavity and a second cavity, wherein a bottom of the second cavity exposes the cathode layer;

evaporating a hole injection layer in the first cavity, wherein the hole injection layer is disposed on the anode layer;

evaporating a hole transport layer on the hole injection layer;

evaporating an electron injection layer on the cathode layer;

evaporating an electron transport layer on the electron injection layer;

evaporating an emitting layer on the second insulator; and disposing a reference voltage layer on a side of the emitting layer.

15. The manufacturing method according to claim 14, wherein the emitting layer comprises:

a first color emitting material;

a second color emitting material, disposed by a side of the first color emitting material; and

a third color emitting material, disposed by a side of the second color emitting material,

wherein the pixel emits the white light by mixing a first color light, a second color light and a third color light, which is respectively emitted from the first color emitting material, the second color emitting material and the third color emitting material.

16. The manufacturing method according to claim 14, wherein the emitting layer comprises:

a first color emitting material;

a second color emitting material, disposed on the first color emitting material; and

a third color emitting material, disposed on the second color emitting material,

wherein the pixel emits the white light by mixing a first color light, a second color light and a third color light, which is respectively emitted from the first color emitting material, the second color emitting material and the third color emitting material.

17. The manufacturing method according to claim 14, wherein the material of the emitting layer comprises at least two different color emitting materials.

18. The manufacturing method according to claim 14, wherein the reference voltage layer is disposed between the first cavity and the second cavity and disposed under the emitting layer, wherein the manufacturing method further comprises:

disposing a low impedance conductor layer on the emitting layer.

19. The manufacturing method according to claim 14, wherein the reference voltage layer is disposed between the first cavity and the second cavity and disposed under the emitting layer, wherein the manufacturing method further comprises:

performing a doping process to implant a dopant in the emitting layer

20. The manufacturing method according to claim 14, wherein the reference voltage layer is disposed on the emitting layer, wherein the manufacturing method further comprises:

disposing a third insulator between the reference voltage layer and the emitting layer

* * * * *

| | | | |
|----------------|--|---------|------------|
| 专利名称(译) | 有机发光二极管面板及使用其的制造方法 | | |
| 公开(公告)号 | US20180108718A1 | 公开(公告)日 | 2018-04-19 |
| 申请号 | US15/787310 | 申请日 | 2017-10-18 |
| [标]申请(专利权)人(译) | 敦泰科技有限公司 | | |
| 申请(专利权)人(译) | FOCALTECH SYSTEMS CO. , LTD. | | |
| 当前申请(专利权)人(译) | FOCALTECH SYSTEMS CO. , LTD. | | |
| [标]发明人 | WANG CHUN FU | | |
| 发明人 | WANG, CHUN-FU | | |
| IPC分类号 | H01L27/32 H01L51/52 H01L51/50 H01L51/05 | | |
| CPC分类号 | H01L27/3244 H01L51/5206 H01L51/5221 H01L51/5056 H01L51/0508 H01L27/3262 H01L51/5012 H01L51/5036 H01L51/504 H01L51/5072 H01L51/52 H01L51/5203 H01L51/5296 H01L2251/5392 | | |
| 优先权 | 106121905 2017-06-30 TW 105133678 2016-10-19 TW | | |
| 其他公开文献 | US10038036 | | |
| 外部链接 | Espacenet USPTO | | |

摘要(译)

在本发明中提供了一种有机发光二极管面板及使用该面板的制造方法。OLED面板至少包括像素。像素包括阳极导电层，绝缘层，发光层（EML），阴极层和参考电压层。阳极导电层设置在透明基板上。绝缘层设置在阳极导电层上并具有第一腔和第二腔，其中在第一阳极层和第二腔的底部之间存在距离。存在空穴注入层（HIL）和空穴传输层（HTL）。HIL设置在第一阳极导电层上。HTL设置在HIL上。在第二腔中存在阴极层，电子注入层（EIL）和电子传输层（ETL）。阴极层通过第二腔的底部暴露。EIL设置在阴极层上。ETL位于EIL上。EML设置在绝缘层上。参考电压层设置在EML上。

